

CATÁLOGO

OUTDOOR, INDOOR & FABRICS



2023



EL VALOR
DEL CONFORT

00 GUÍAS RÁPIDAS

01 PARASOLES

Playa	15
Aqua	17
Aquatex	19
Feria	21
Urban	22-23
Arena	25
Via	27
Patio	29
Zoco	31
Ruedo	33
Plaza	35
Heavy Duty	36
Lateral	42
Lateral Plus	43
Máster	44
Giant	50
Madera	56
Estampación	61
Cortinas	65
Canal vierteaguas	67

02 BASES

Cemento	70
Carcasa resina/PPP	71
Metálicas	73
Empotrables	73

03 MOBILIARIO

Muebles aluminio	77
Balinesas aluminio	79
Muebles madera	81
Tumbonas madera	85
Balinesas madera	87

04 COJINES

Puffs	90
Decorativos	91
Cojín tumbona	92
Hostelería	94
Interior/Exterior	95

05 COMPLEMENTOS

Separadores	99
Infrarrojos cortos	103
Iluminación LED	105

06 FUNDAS PROTECTORAS

Ripstop	108
Miltitex	109

07 CARTA DE COLORES

Acrylic Basic	112
Olefin	112
Acrylic Masa Soft	113
Polyester	113
Acrylic Masa Forte	114
Textilene	114
Nautic	115



REF. 819
PLAYA

LINEA FORTE pág. 13

Ø1,8 m

ESTRUCTURA / STRUCTURE / PIED
 Acero inox
 Aluminio

BASES / BASES / PIED
 HS20-TH22-MP20

TEJIDOS / FABRICS / TISSUS
 Acrylic Basic Acrylic Masa Soft Olefin Polyester



REF. 839
AQUA

LINEA FORTE pág. 15

Ø2 m

ESTRUCTURA / STRUCTURE / PIED
 Aluminio

BASES / BASES / PIED
 HS20-TH22-MP20-TH30-GY20

TEJIDOS / FABRICS / TISSUS
 Acrylic Basic Acrylic Masa Soft Olefin Polyester



REF. 833
AQUATEX

LINEA FORTE pág. 17

Ø2 m

ESTRUCTURA / STRUCTURE / PIED
 Aluminio

BASES / BASES / PIED
 HS20-TH22-MP20-TH30-GY20

TEJIDOS / FABRICS / TISSUS
 Textilene



REF. 821
FERIA

LINEA FORTE pág. 19

Ø2 m

ESTRUCTURA / STRUCTURE / PIED
 Aluminio

BASES / BASES / PIED
 HS15-HS20-TH22-MP20

TEJIDOS / FABRICS / TISSUS
 Acrylic Basic Acrylic Masa Soft Olefin Polyester



REF. 815
URBAN

LINEA FORTE pág. 21

1,55x1,55 m | 1,8x1,3 m

ESTRUCTURA / STRUCTURE / PIED
 Acero

BASES / BASES / PIED
 HS20-TH22-TH30-MP20

TEJIDOS / FABRICS / TISSUS
 Acrylic Basic Acrylic Masa Soft Olefin Polyester



CEMENTO PINTADO
TH11

LINEA FORTE pág. 68

PESO / WEIGHT / POIDS
 11 kg

MEDIDA / MEASURE / DIMENSIONS
 36x26x6/30 cm

Ø TUBO / Ø TUBE / Ø POUR MÂT
 Ø30-38 mm

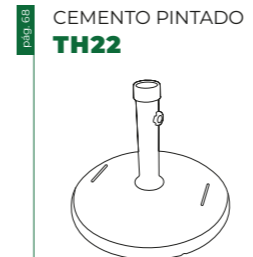

CEMENTO PINTADO
TH22

LINEA FORTE pág. 68

PESO / WEIGHT / POIDS
 22 kg

MEDIDA / MEASURE / DIMENSIONS
 Ø48x5,5 cm

Ø TUBO / Ø TUBE / Ø POUR MÂT
 Ø38-48 mm

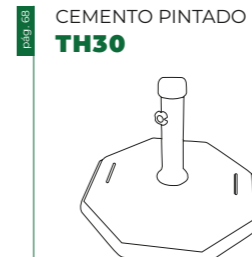

CEMENTO PINTADO
TH30

LINEA FORTE pág. 68

PESO / WEIGHT / POIDS
 30 kg

MEDIDA / MEASURE / DIMENSIONS
 50x50x7/34 cm

Ø TUBO / Ø TUBE / Ø POUR MÂT
 Ø38-48 mm



CEMENTO PINTADO
TH137

LINEA FORTE pág. 68

PESO / WEIGHT / POIDS
 37 kg

MEDIDA / MEASURE / DIMENSIONS
 50x50x14/44 cm

Ø TUBO / Ø TUBE / Ø POUR MÂT
 Ø38-48 mm



CEMENTO PINTADO
LTH50

LINEA FORTE pág. 68

PESO / WEIGHT / POIDS
 50 kg

MEDIDA / MEASURE / DIMENSIONS
 54x54x8/36 cm

Ø TUBO / Ø TUBE / Ø POUR MÂT
 Ø40-58 mm



REF. 892 | 888
ARENA

LINEA BASIC pág. 22-23

Ø2,5 m | 2x2 m

ESTRUCTURA / STRUCTURE / PIED
 Aluminio

BASES / BASES / PIED
 HS20-TH22-TH30-MP20

TEJIDOS / FABRICS / TISSUS
 Acrylic Basic Acrylic Masa Soft Olefin Polyester



REF. 875
VIA

LINEA FORTE pág. 25

2x2 m

ESTRUCTURA / STRUCTURE / PIED
 Aluminio

BASES / BASES / PIED
 HS20-TH22-TH30-MP20

TEJIDOS / FABRICS / TISSUS
 Acrylic Basic Acrylic Masa Soft Olefin Polyester



REF. 897
PATIO

LINEA FORTE pág. 27

2,5x2,5 m

ESTRUCTURA / STRUCTURE / PIED
 Aluminio

BASES / BASES / PIED
 TH30-TH137-MP40-HS40

TEJIDOS / FABRICS / TISSUS
 Acrylic Basic Acrylic Masa Soft Olefin Polyester



REF. 885
ZOCO

LINEA BASIC pág. 28

2x3 m

ESTRUCTURA / STRUCTURE / PIED
 Aluminio

BASES / BASES / PIED
 TH30-TH137-MP40-HS40

TEJIDOS / FABRICS / TISSUS
 Acrylic Basic Acrylic Masa Soft Olefin Polyester



REF. 886
RUEDO

LINEA BASIC pág. 31

Ø3 m

ESTRUCTURA / STRUCTURE / PIED
 Aluminio

BASES / BASES / PIED
 TH30-TH137-MP40-HS40

TEJIDOS / FABRICS / TISSUS
 Acrylic Basic Acrylic Masa Soft Olefin Polyester



CEMENTO PINTADO
MV50N

LINEA FORTE pág. 68

PESO / WEIGHT / POIDS
 50 kg

MEDIDA / MEASURE / DIMENSIONS
 57x57x7 cm

Ø TUBO / Ø TUBE / Ø POUR MÂT
 Ø25-50 mm

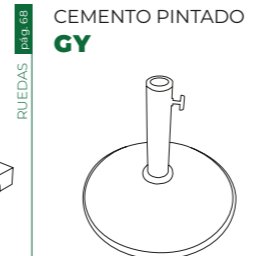

CEMENTO PINTADO
GY

LINEA FORTE pág. 68

PESO / WEIGHT / POIDS
 20-30-50-70 kg

MEDIDA / MEASURE / DIMENSIONS
 *Consultar pág 68

Ø TUBO / Ø TUBE / Ø POUR MÂT
 *Consultar pág 68

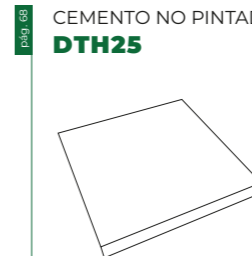

CEMENTO NO PINTADO
DTH25

LINEA FORTE pág. 68

PESO / WEIGHT / POIDS
 7,22 kg

MEDIDA / MEASURE / DIMENSIONS
 47x47x7 cm



CEMENTO PINTADO
CDLC30

LINEA FORTE pág. 68

PESO / WEIGHT / POIDS
 8,18 kg

MEDIDA / MEASURE / DIMENSIONS
 50x50x5 cm

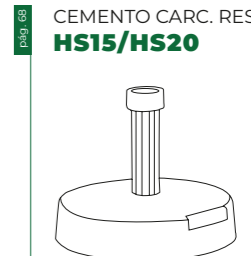

CEMENTO CARC. RES.
HS15/HS20

LINEA FORTE pág. 68

PESO / WEIGHT / POIDS
 15 kg / 20 kg

MEDIDA / MEASURE / DIMENSIONS
 *Consultar pág 69

Ø TUBO / Ø TUBE / Ø POUR MÂT
 *Consultar pág 69



REF. 898
PLAZA

LINEA BASIC pág. 33

3x3 m

ESTRUCTURA / STRUCTURE / PIED
 Aluminio

BASES / BASES / PIED
 TH30-TH137-MP40-HS40-GY30

TEJIDOS / FABRICS / TISSUS
 Acrylic Basic Acrylic Masa Soft Olefin Polyester



REF. 876 | 887 | 899 | 895
HEAVY DUTY

LINEA FORTE pág. 34

Ø3 m | 2x3 m | 3x3 m | 3,5x3,5 m

ESTRUCTURA / STRUCTURE / PIED
 Aluminio

BASES / BASES / PIED
 MP40-LTH50-50ET-245-CAJÓN-GY50-GY70

TEJIDOS / FABRICS / TISSUS
 Acrylic Basic Acrylic Masa Soft Acrylic Masa Forte Olefin 250 Polyester



REF. 897
LATERAL

LINEA FORTE pág. 34

3x3 m

ESTRUCTURA / STRUCTURE / PIED
 Aluminio

BASES / BASES / PIED
 4 LOSAS CDLC30- 4 LOSAS DTH25

TEJIDOS / FABRICS / TISSUS
 Acrylic Basic Acrylic Masa Soft Olefin Polyester



REF. 879
LATERAL P.

LINEA BASIC pág. 40

3x3 m

ESTRUCTURA / STRUCTURE / PIED
 Aluminio

BASES / BASES / PIED
 4 LOSAS CDLC30- 4 LOSAS DTH25

TEJIDOS / FABRICS / TISSUS
 Acrylic Basic Acrylic Masa Soft Olefin Polyester PU



REF. 889 | 884 | 894
MÁSTER

LINEA FORTE pág. 42

3x3 m | 3x4 m | 4x4 m

ESTRUCTURA / STRUCTURE / PIED
 Aluminio

BASES / BASES / PIED
 SHBC+4 LOSETAS-ET70-CAJÓN

TEJIDOS / FABRICS / TISSUS
 Acrylic Basic Acrylic Masa Soft Olefin 250 Polyester PU



CEMENTO CARC. RES.
HS40

LINEA FORTE pág. 69

PESO / WEIGHT / POIDS
 40 kg

MEDIDA / MEASURE / DIMENSIONS
 40x40x13/33 cm

Ø TUBO / Ø TUBE / Ø POUR MÂT
 Ø21-54 mm



CEMENTO CARC. RES.
HSN40

LINEA FORTE pág. 69

PESO / WEIGHT / POIDS
 40 kg

MEDIDA / MEASURE / DIMENSIONS
 40x40x13/33 cm

Ø TUBO / Ø TUBE / Ø POUR MÂT
 Ø21-52 mm

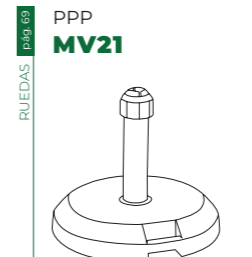

PPP
MV21

LINEA FORTE pág. 69

PESO / WEIGHT / POIDS
 21 kg

MEDIDA / MEASURE / DIMENSIONS
 Ø43x8 cm

Ø TUBO / Ø TUBE / Ø POUR MÂT
 Ø18-53 mm

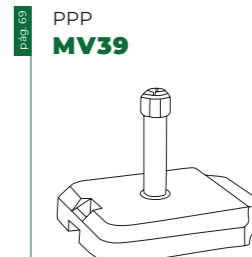

PPP
MV39

LINEA FORTE pág. 69

PESO / WEIGHT / POIDS
 39 kg

MEDIDA / MEASURE / DIMENSIONS
 54x47x9 cm

Ø TUBO / Ø TUBE / Ø POUR MÂT
 Ø18-53 mm

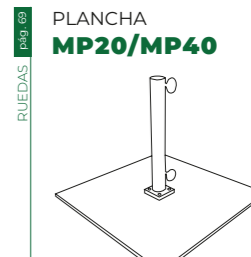

PLANCHA
MP20/MP40

LINEA FORTE pág. 71

PESO / WEIGHT / POIDS
 20 kg / 40 kg

MEDIDA / MEASURE / DIMENSIONS
 60x60x1/31 cm

Ø TUBO / Ø TUBE / Ø POUR MÂT
 Ø40 mm / Ø50 mm



REF. 864 | 865
GIANT

LINEA FORTE pág. 48

4x4 m | 5x5 m

ESTRUCTURA / STRUCTURE / PIED
 Aluminio

BASES / BASES / PIED
 EMP86 (opcional)

TEJIDOS / FABRICS / TISSUS
 Acrylic Masa Forte Olefin 250 Polyester PU



REF. 841 | 842 | 843 | 844
MADERA

LINEA FORTE pág. 54

Ø2 m | 2x2 m | Ø3 m | 3x3 m

ESTRUCTURA / STRUCTURE / PIED
 Acero

BASES / BASES / PIED
 TH30-TH137-MP40-HS40

TEJIDOS / FABRICS / TISSUS
 Acrylic Basic Acrylic Masa Soft Olefin Polyester



EMPOTRABLE
50ET/70ET

LINEA FORTE pág. 71

PESO / WEIGHT / POIDS
 3 kg / 4 kg

MEDIDA / MEASURE / DIMENSIONS
 12x12x4/29

Ø TUBO / Ø TUBE / Ø POUR MÂT
 Ø48x50 mm / Ø65 mm (BASE 245/245-90)

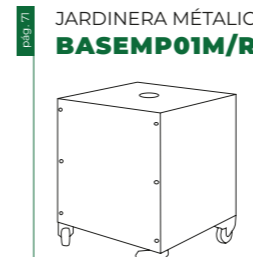

JARDINERA METALICA
BASEMP01M/R

LINEA FORTE pág. 71

PESO / WEIGHT / POIDS
 58 kg

MEDIDA / MEASURE / DIMENSIONS
 63x63x3 cm

Ø TUBO / Ø TUBE / Ø POUR MÂT
 Mástil Máster (71x71mm)

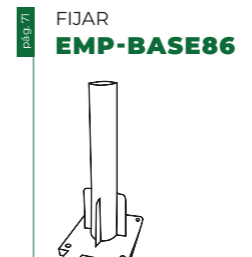

FIJAR
EMP-BASE86

LINEA FORTE pág. 71

PESO / WEIGHT / POIDS
 12 kg

MEDIDA / MEASURE / DIMENSIONS
 20x20x53

Ø TUBO / Ø TUBE / Ø POUR MÂT
 Mástil Giant (Ø86 mm)

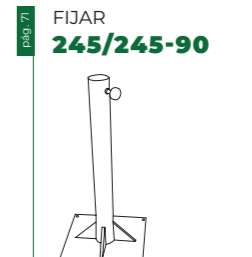

FIJAR
245/245-90

LINEA FORTE pág. 71

PESO / WEIGHT / POIDS
 7,22 kg / 8,18 kg

MEDIDA / MEASURE / DIMENSIONS
 25x25x1/50 cm

Ø TUBO / Ø TUBE / Ø POUR MÂT
 hasta Ø50 mm / hasta Ø90 mm

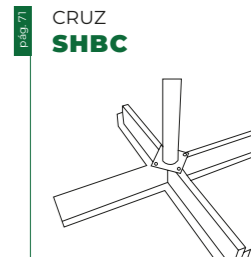

CRUZ
SHBC

LINEA FORTE pág. 71

PESO / WEIGHT / POIDS
 14 kg

MEDIDA / MEASURE / DIMENSIONS
 97x97x6 cm

Ø TUBO / Ø TUBE / Ø POUR MÂT
 Mástil Máster (71x71 mm)

REF. CHAV1
SILLÓN BRAZOS

ALUMINIO **pag. 75**

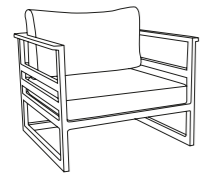

CON BRAZOS
MEDIDA / MEASURE / DIMENSIONS
70x76x65/30 cm
PESO / WEIGHT / POIDS
24,8 kg
TEJIDOS / FABRICS / TISSUS
Acrylic Basic Acrylic Masa Soft
Nautic Bio Plus Nautic Class
Nautic Melange Polyester

REF. CHAVISB
SILLÓN S.BRAZOS

ALUMINIO **pag. 75**

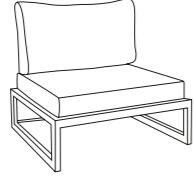

SIN BRAZOS
MEDIDA / MEASURE / DIMENSIONS
70x76x66 cm
PESO / WEIGHT / POIDS
24,4 kg
TEJIDOS / FABRICS / TISSUS
Acrylic Basic Acrylic Masa Soft
Nautic Bio Plus Nautic Class
Nautic Melange Polyester

REF. CHAV2B
SOFÁ BRAZOS

ALUMINIO **pag. 75**

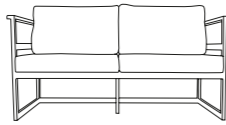

CON BRAZOS
MEDIDA / MEASURE / DIMENSIONS
135x76x65 cm
PESO / WEIGHT / POIDS
42,8 kg
TEJIDOS / FABRICS / TISSUS
Acrylic Basic Acrylic Masa Soft
Nautic Bio Plus Nautic Class
Nautic Melange Polyester

REF. CHAV2SB
SOFÁ S. BRAZOS

ALUMINIO **pag. 75**

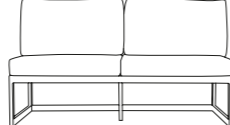

SIN BRAZOS
MEDIDA / MEASURE / DIMENSIONS
70x76x65/30 cm
PESO / WEIGHT / POIDS
24,8 kg
TEJIDOS / FABRICS / TISSUS
Acrylic Basic Acrylic Masa Soft
Nautic Bio Plus Nautic Class
Nautic Melange Polyester

REF. CHAVIR
RINCONERA

ALUMINIO **pag. 75**

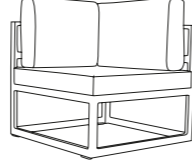

MEDIDA / MEASURE / DIMENSIONS
76x76x66 cm
PESO / WEIGHT / POIDS
28,2 kg
TEJIDOS / FABRICS / TISSUS
Acrylic Basic Acrylic Masa Soft
Nautic Bio Plus Nautic Class
Nautic Melange Polyester

REF. BS180
SEPARADOR PLAYA

pag. 97

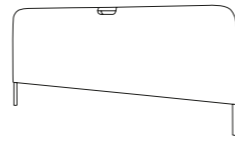

MEDIDA / MEASURE / DIMENSIONS
80x180 cm
PESO / WEIGHT / POIDS
4,70 kg
TEJIDOS / FABRICS / TISSUS
Acrylic Masa Soft Textilene

REF. SPTZ150MS
SEPARADOR TERRAZA

pag. 97

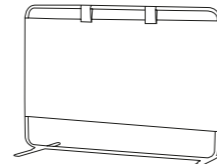

MEDIDA / MEASURE / DIMENSIONS
105x150 cm
PESO / WEIGHT / POIDS
6,30 kg
TEJIDOS / FABRICS / TISSUS
PVC

REF. SPR150PVC
SEPARADOR COVID

pag. 97

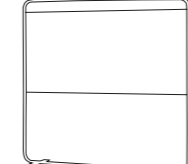

MEDIDA / MEASURE / DIMENSIONS
150x150 cm
PESO / WEIGHT / POIDS
7,24 kg
TEJIDOS / FABRICS / TISSUS
Acrylic Masa Soft

REF. SEPM100H
SEPARADOR JARDINERA

pag. 97

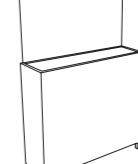

MEDIDA / MEASURE / DIMENSIONS
96,5x22x140 cm
PESO / WEIGHT / POIDS
38 kg
ESTRUCTURA / STRUCTURE / PIED
Plancha galvanizada

REF. SEPM100H
SEPARADOR JARDINERA

pag. 97



MEDIDA / MEASURE / DIMENSIONS
96,5x22x91 cm
ESTRUCTURA / STRUCTURE / PIED
Plancha galvanizada

REF. CHAV90
MESA

ALUMINIO **pag. 75**

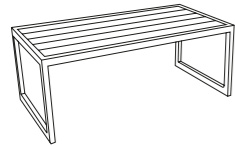

MEDIDA / MEASURE / DIMENSIONS
90x48x44 cm
PESO / WEIGHT / POIDS
5,5 kg

REF. CMRAL150
CAMASTRO RECL.

ALUMINIO **pag. 77**

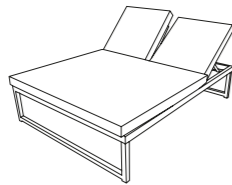

MEDIDA / MEASURE / DIMENSIONS
150x200x41 cm
PESO / WEIGHT / POIDS
60 kg
TEJIDOS / FABRICS / TISSUS
Acrylic Basic Acrylic Masa Soft
Nautic Bio Plus Nautic Class
Nautic Melange

REF. CBRAL-X150
BALINESA RECL.

ALUMINIO **pag. 77**

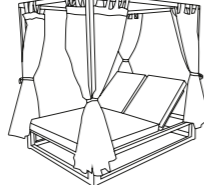

MEDIDA / MEASURE / DIMENSIONS
150x200x200 cm
PESO / WEIGHT / POIDS
90 kg
TEJIDOS / FABRICS / TISSUS
Acrylic Basic Acrylic Masa Soft
Nautic Bio Plus Nautic Class
Nautic Melange

REF. CHSL45
MESA CUADRADA

MADERA **pag. 79**

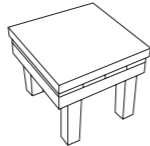

MEDIDA / MEASURE / DIMENSIONS
45x45x34 cm
PESO / WEIGHT / POIDS
8 kg
TEJIDOS / FABRICS / TISSUS
Acrylic Basic Acrylic Masa Soft
Nautic Bio Plus Nautic Class
Nautic Melange Polyester

REF. CHSL4590
MESA RECTANG.

MADERA **pag. 79**

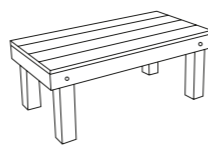

MEDIDA / MEASURE / DIMENSIONS
90x45x34 cm
PESO / WEIGHT / POIDS
12 kg

REF. EST20CA
LÁMPARA CARBONO

pag. 101

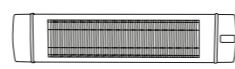

MEDIDA / MEASURE / DIMENSIONS
88x19x8 cm
PESO / WEIGHT / POIDS
3 kg
POTENCIA / POWER / PUISSANCE
4 potencias

REF. EST20HA
LÁMPARA HÁLOGENA

pag. 101

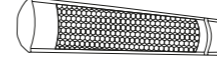

MEDIDA / MEASURE / DIMENSIONS
68x11x7 cm
PESO / WEIGHT / POIDS
1,6 kg
POTENCIA / POWER / PUISSANCE
4 potencias

REF. EST20LG
LÁMPARA HÁLOGENA

pag. 101



MEDIDA / MEASURE / DIMENSIONS
46x19x12 cm
PESO / WEIGHT / POIDS
2,8 kg
POTENCIA / POWER / PUISSANCE
1 potencias

REF. EST-PIE
SOPORTE PIE

pag. 101



MEDIDA / MEASURE / DIMENSIONS
Ajustable de 1,2 a 2,1 cm
PESO / WEIGHT / POIDS
9 kg

REF. EST-SOP
SOPORTE PARASOL

pag. 101

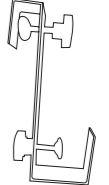

MEDIDA / MEASURE / DIMENSIONS
20,5x7,5x4 cm
PESO / WEIGHT / POIDS
1,17 kg

REF. CHSL1
SILLÓN 1 PLZ

MADERA **pag. 79**

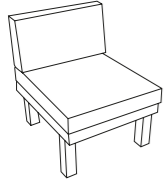

MEDIDA / MEASURE / DIMENSIONS
60x74x75/34 cm
PESO / WEIGHT / POIDS
13 kg
TEJIDOS / FABRICS / TISSUS
Acrylic Basic Acrylic Masa Soft
Nautic Bio Plus Nautic Class
Nautic Melange

REF. CHSLIR
RINCONERA

MADERA **pag. 79**

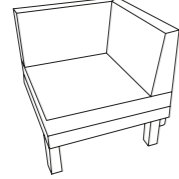

MEDIDA / MEASURE / DIMENSIONS
74x74x75/34 cm
PESO / WEIGHT / POIDS
18 kg
TEJIDOS / FABRICS / TISSUS
Acrylic Basic Acrylic Masa Soft
Nautic Bio Plus Nautic Class
Nautic Melange

REF. CHSL2
SOFÁ 2 PLZ

MADERA **pag. 79**

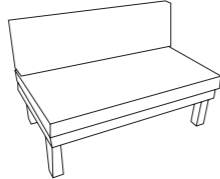

MEDIDA / MEASURE / DIMENSIONS
120x73,5x75/34 cm
PESO / WEIGHT / POIDS
21 kg
TEJIDOS / FABRICS / TISSUS
Acrylic Basic Acrylic Masa Soft
Nautic Bio Plus Nautic Class
Nautic Melange

REF. CHSL200
TUMBONA

MADERA **pag. 79**

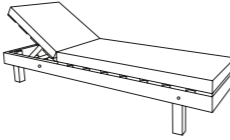

MEDIDA / MEASURE / DIMENSIONS
60x200x34 cm
PESO / WEIGHT / POIDS
21 kg
TEJIDOS / FABRICS / TISSUS
Acrylic Basic Acrylic Masa Soft
Nautic Bio Plus Nautic Class
Nautic Melange

REF. CMR150
TUMBONA DOBLE

MADERA **pag. 83**

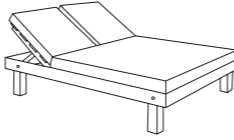

MEDIDA / MEASURE / DIMENSIONS
125,5x200x40,5 cm
PESO / WEIGHT / POIDS
94 kg
TEJIDOS / FABRICS / TISSUS
Acrylic Basic Acrylic Masa Soft
Nautic Bio Plus Nautic Class
Nautic Melange

CORTINAS PARASOL

pag. 85

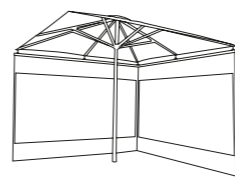

MEDIDA / MEASURE / DIMENSIONS
2/3/4 y 5 m
TEJIDOS / FABRICS / TISSUS
PVC transparente + PVC color
PVC transparente + Acrylic Masa Forte
PVC transparente + Olefin

CANAL VIERTEAGUAS

pag. 85

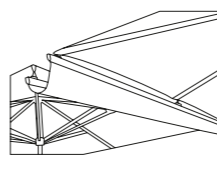

MEDIDA / MEASURE / DIMENSIONS
2/3/4 y 5 m
TEJIDOS / FABRICS / TISSUS
PVC transparente + Acrylic Masa Forte

REF. ILED50-BAT
ILED

pag. 103

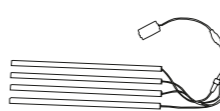

MEDIDA / MEASURE / DIMENSIONS
4 tiras LED 50 cm

FUNDAS RIPSTOP

pag. 106

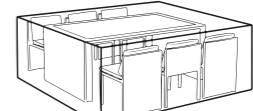

MEDIDA / MEASURE / DIMENSIONS
*Consultar

FUNDAS MULTITEX

pag. 107

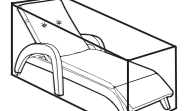

MEDIDA / MEASURE / DIMENSIONS
*Consultar

REF. CHSL6070
RESPALDO RECL.

MADERA **pag. 85**

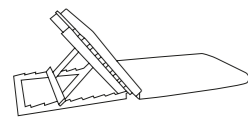

MEDIDA / MEASURE / DIMENSIONS
60x70 cm
PESO / WEIGHT / POIDS
8 kg
TEJIDOS / FABRICS / TISSUS
Acrylic Basic Acrylic Masa Soft
Nautic Bio Plus Nautic Class
Nautic Melange

REF. CBB150
BALINESA FIJA

MADERA **pag. 85**

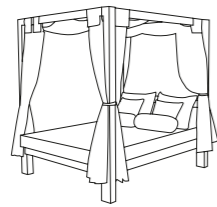

MEDIDA / MEASURE / DIMENSIONS
168,5x200x207 cm
PESO / WEIGHT / POIDS
125 kg
TEJIDOS / FABRICS / TISSUS
Nautic Bio Plus Nautic Class

REF. CBR150
BALINESA RECL.

MADERA **pag. 85**

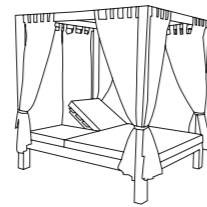

MEDIDA / MEASURE / DIMENSIONS
168,5x200x207 cm
PESO / WEIGHT / POIDS
115 kg
TEJIDOS / FABRICS / TISSUS
Nautic Bio Plus Nautic Class

COJÍN CUADRANTE

pag. 89

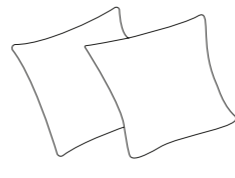

MEDIDA / MEASURE / DIMENSIONS
40x40 cm
45x45 cm
50x50 cm
55x55 cm
60x60 cm
TEJIDOS / FABRICS / TISSUS
Acrylic Basic Acrylic Masa Soft Nautic Class Nautic Bio Plus Nautic Melange

COJÍN RECTANGULAR

pag. 89

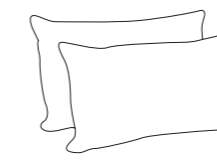

MEDIDA / MEASURE / DIMENSIONS
30x50 cm
60x40 cm
60x75 cm
TEJIDOS / FABRICS / TISSUS
Acrylic Basic Acrylic Masa Soft Nautic Class Nautic Bio Plus Nautic Melange

COJÍN RULO

pag. 89

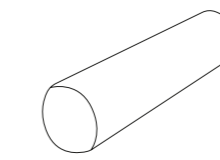

MEDIDA / MEASURE / DIMENSIONS
Ø20x60 cm
TEJIDOS / FABRICS / TISSUS
Acrylic Basic Acrylic Masa Soft Nautic Class Nautic Bio Plus Nautic Melange

REF. PF111 / PF112
PUF

pag. 88

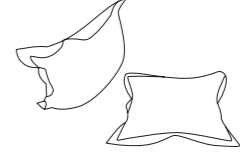

MEDIDA / MEASURE / DIMENSIONS
*Consultar
TEJIDOS / FABRICS / TISSUS
Acrylic Basic Acrylic Masa Soft Nautic Class Nautic Bio Plus Nautic Melange

REF. PF1113 / PF114
PUF

pag. 88

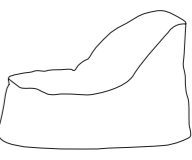

MEDIDA / MEASURE / DIMENSIONS
*Consultar
TEJIDOS / FABRICS / TISSUS
Acrylic Basic Acrylic Masa Soft Nautic Class Nautic Bio Plus Nautic Melange

01 PARASOLES



LÍNEA FORTE Y LÍNEA BASIC

La Grande Motte, Francia
819 | Parasol Playa Ø1,8 m



La Grande Motte, Francia
819 | Parasol Playa Ø1,8 m



REF. 819

PLAYA Ø1,8 m



Parasol de acero inoxidable ideal para playas.

Stainless steel sunshade ideal for beaches.

Parasol en acier inoxydable idéal pour les plages.

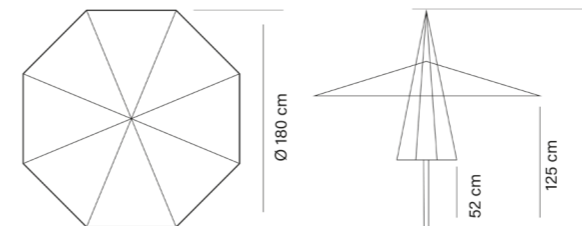

MONTURA DISPONIBLE / AVAILABLE STRUCTURE / STRUCTURE DISPONIBLE

Inox

MÁSTIL / POLE / MÂT

Inox Ø23 mm

Pared / Thickness / Épaisseur 1,5 mm

VARILLAS / RIBS / BALEINES

8 uds zincadas Ø4,6 mm

SOPORTE NO INCLUIDO / SUPPORT NOT INCLUDED / CORNIÈRE OU TUBE INFÉRIEUR NON INCLUS

819TP Pincho de acero inox 99 cm / 819PIN Ángulo de acero zincado 120 cm

BASES COMPATIBLES* / COMPATIBLE BASES* / PIEDS COMPATIBLES*

HS20 - MV21 - MV39 - HS40 - HSN40

TEJIDOS DISPONIBLES / AVAILABLE FABRICS / TISSUS DISPONIBLES

Acrylic Basic Acrylic Masa Soft Olefin 190

819TP

Pincho de acero inox 99 cm
Stainless steel lower pole 99 cm
Tube inférieure en acier inoxydable 99 cm

819PIN

Ángulo de acero zincado 120 cm
Angle steel picket 120 cm
Cornière en acier zingué 120 cm



Montura de acero inox con varillas de acero zincado
Stainless steel frame with zincked steel ribs
Chassis en acier inox avec baleines en acier zingué



Sistema push up
Push up system
Système push up

Melilla, España
839 | Parasol Aqua Ø2 m

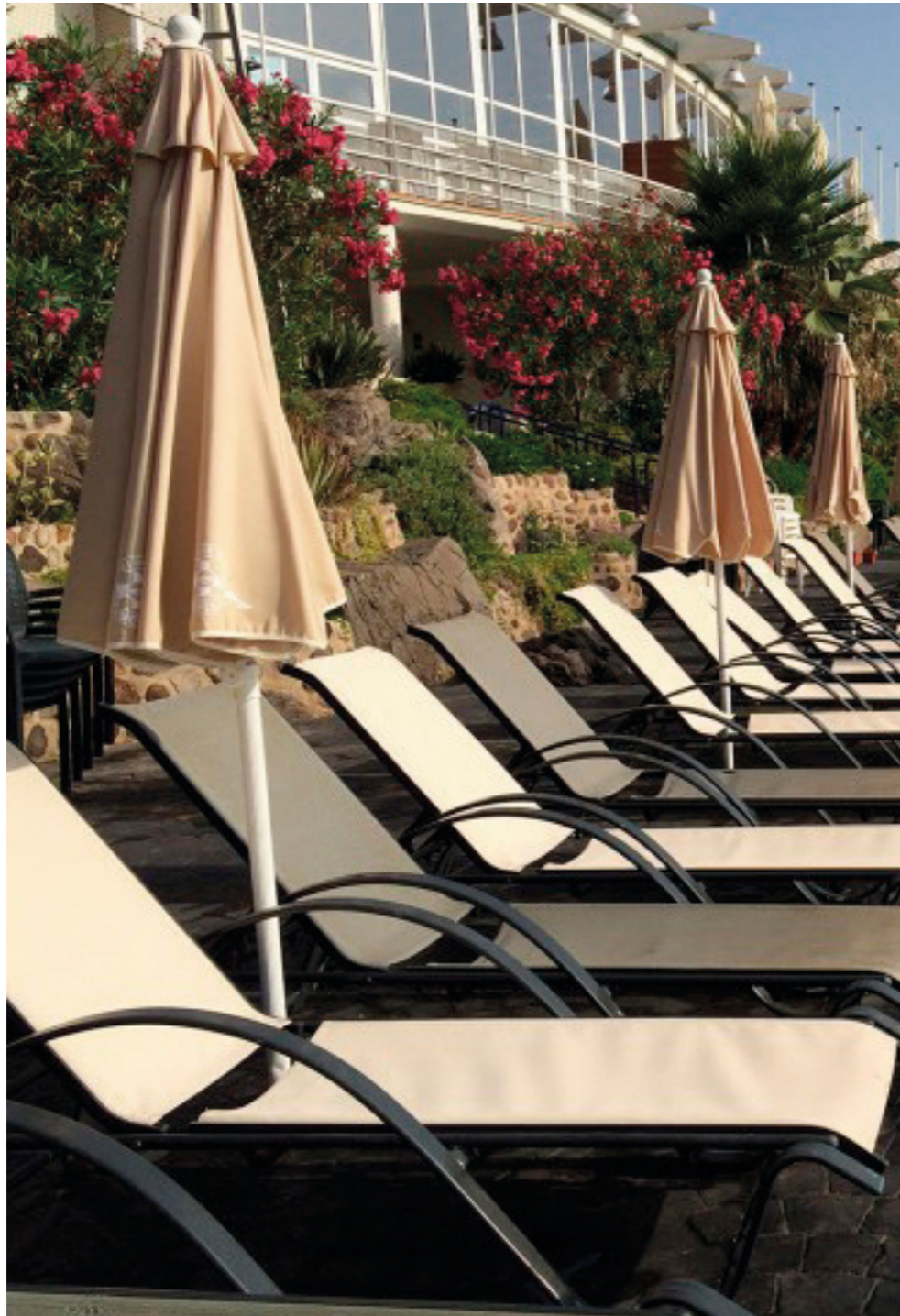

Denia, Alicante (España)
839 | Parasol Aqua Ø2 m



REF. 839

AQUA Ø2 m



Parasol reforzado en aluminio estriado. Ideal para instalaciones.

Reinforced aluminium striated sunshade. Ideal for installations.

Parasol renforcé en aluminium avec mât strié. Idéal pour toute installation.

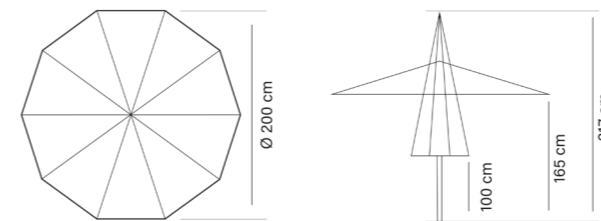

MONTURA DISPONIBLE / AVAILABLE STRUCTURE / STRUCTURE DISPONIBLE

Blanco

MÁSTIL / POLE / MÂT

Aluminio estriado Ø35-40 mm / Aluminum striated Ø35-40 mm /
Aluminium strié Ø35-40 mm
Pared / Thickness / Épaisseur 1,25 mm

VARILLAS / RIBS / BALEINES

10 uds fibra de vidrio Ø6,35 mm / 10 uds fiberglass Ø6,35 mm / 10 uds fibre de
verre Ø6,35 mm

BASES COMPATIBLES* / COMPATIBLE BASES* / PIEDS COMPATIBLES*

HS20 - MP20 - TH22 - TH30 - GY20

TEJIDOS DISPONIBLES / AVAILABLE FABRICS / TISSUS DISPONIBLES

Acrylic Basic Acrylic Masa Soft Polyester Olefin 190

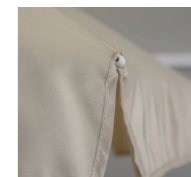

Capitos de PVC
PVC rib end tip
Capuchons PVC



Varillas de fibra de vidrio
Fiberglass ribs
Baleines en fibre de verre

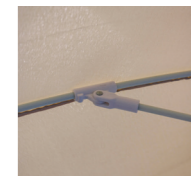

Bisagras de PVC
PVC hinges
Charnières PVC



Sistema push up
Push up system
Système push-up

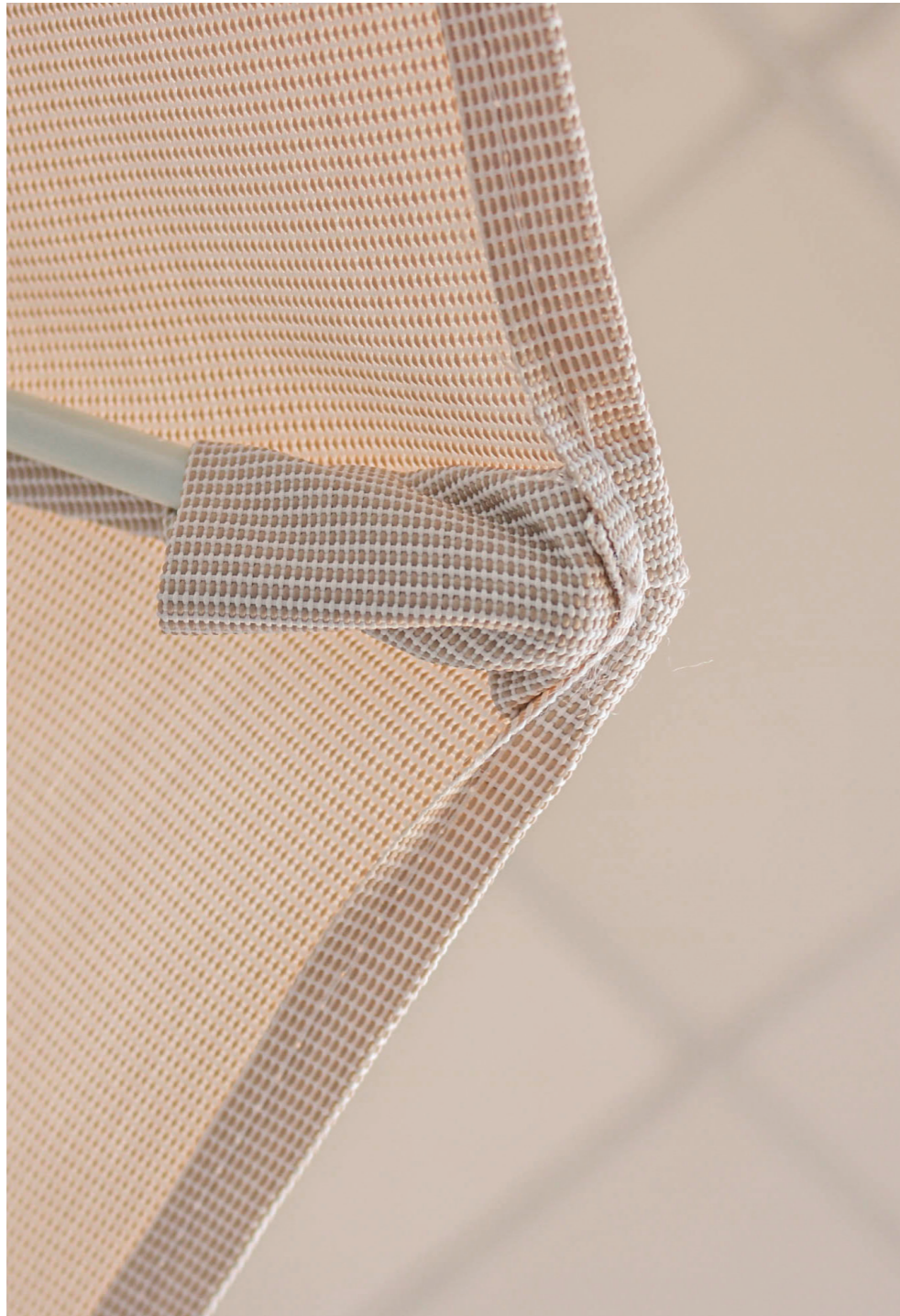

Cádiz, Andalucía (España)
833 | Parasol Aquatex Ø2 m

REF. 833

AQUATEX Ø2 m

Parasol reforzado en aluminio estriado con tejido textilene. Para instalaciones como hoteles, playas, piscinas, etc. Fácil limpieza.

Reinforced aluminum sunshade with textilene fabric. For installations such as hotels, beaches, swimming pools, etc. Easy cleaning.

Parasol renforcé en aluminium avec tissu en textilène. Pour les installations telles que les hôtels, les plages, les piscines, etc. Nettoyage facile.

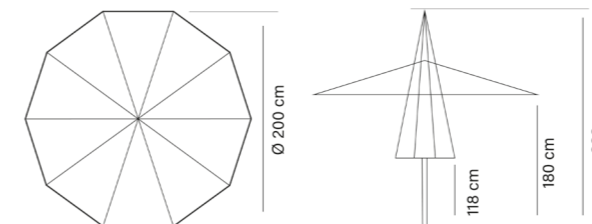

MONTURA DISPONIBLE / AVAILABLE STRUCTURE / STRUCTURE DISPONIBLE

Blanco

MÁSTIL / POLE / MÂT

Aluminio estriado / Aluminum striated / Aluminium strie Ø35-40 mm
Pared / Thickness / Épaisseur 1,25 mm

VARILLAS / RIBS / BALEINES

10 uds fibra de vidrio de Ø8 mm / 10 uds Ø8 mm fiberglass / 10 uds en fibre de verre Ø8 mm

BASES COMPATIBLES* / COMPATIBLE BASES* / PIEDS COMPATIBLES*

HS20 - MP20 - TH22 - TH30 - GY20

TEJIDOS DISPONIBLES / AVAILABLE FABRICS / TISSUS DISPONIBLES

Textilene



Varillas en fibra de vidrio
Fiberglass ribs
Baleines en fibre de verre

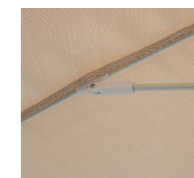

Bisagras de PVC
PVC hinges
Charnières PVC



Sistema push up
Push up system
Système push-up



REF. 821

FERIA Ø2 m

Parasol de aluminio inclinable con varillas de acero.

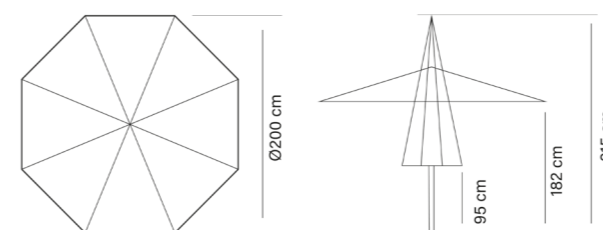
*Tilting aluminium sunshade with steel ribs.**Parasol inclinable avec mât en aluminium et baleines en acier zingué.***MONTURA DISPONIBLE / AVAILABLE STRUCTURE / STRUCTURE DISPONIBLE**
 Blanco
MÁSTIL / POLE / MÂTAluminio / Aluminum Ø29-32 mm
Pared / Thickness / Épaisseur 1 mm**VARILLAS / RIBS / BALEINES**

8 uds acero Ø3,8 mm / 8 uds stell Ø3,8 mm / 8 uds acier Ø3,8 mm

BASES COMPATIBLES* / COMPATIBLE BASES* / PIEDS COMPATIBLES*

HS15 - HS20 - MP20 - TH22

TEJIDOS DISPONIBLES / AVAILABLE FABRICS / TISSUS DISPONIBLES

Acrylic Basic Acrylic Masa Soft Polyester Olefin 190

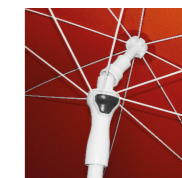
Sistema push up y
inclinable*With tilt and Push
up system**Avec inclinaison et
système push up*

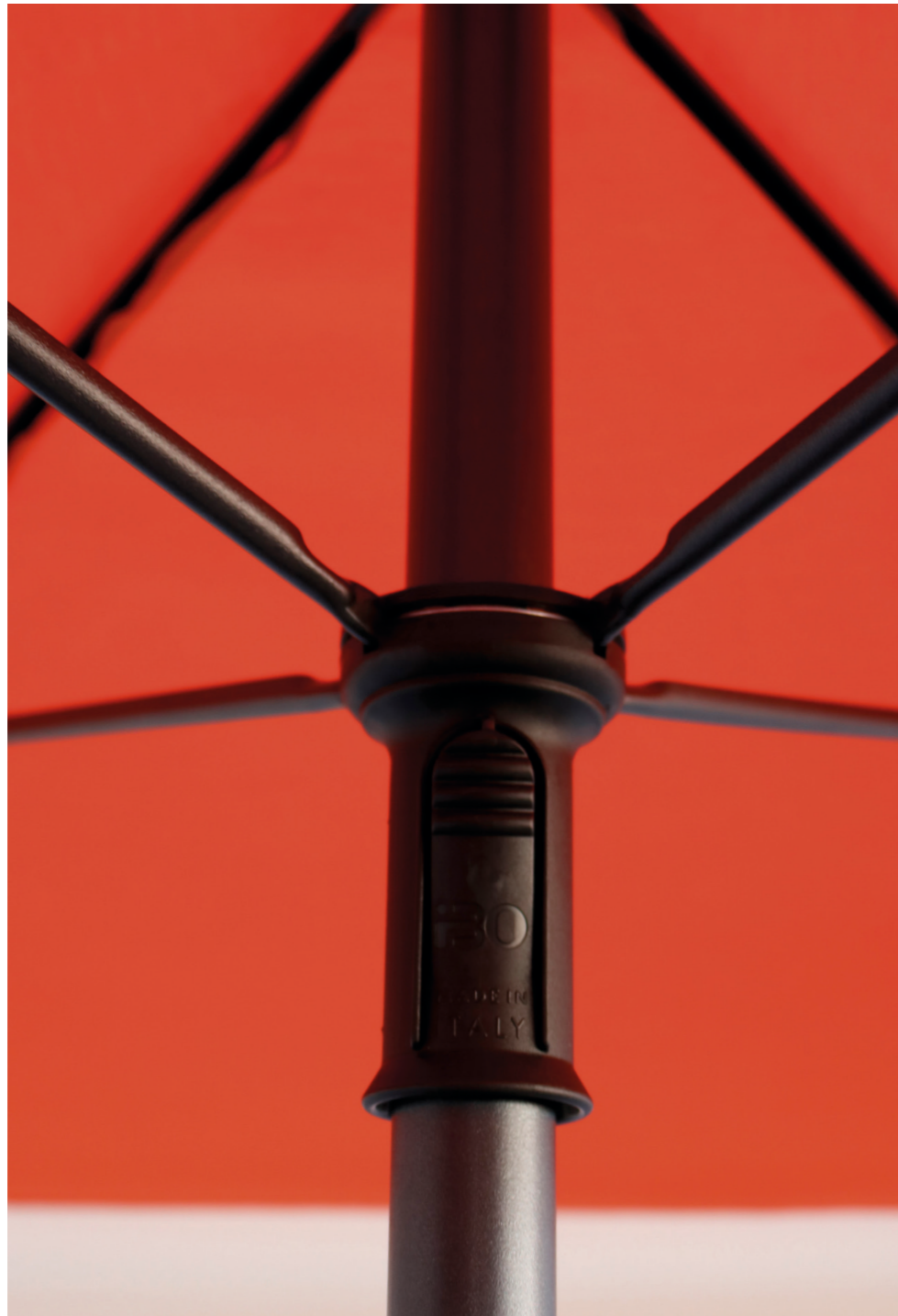

REF. CU815 (1,55x1,55 m) | RE815 (1,8x1,3 m)

URBAN



Parasol reforzado para instalaciones urbanas con espacios reducidos.

Reinforced sunshade for urban installations in small spaces.

Parasol renforcé pour les installations urbaines avec peu d'espace.

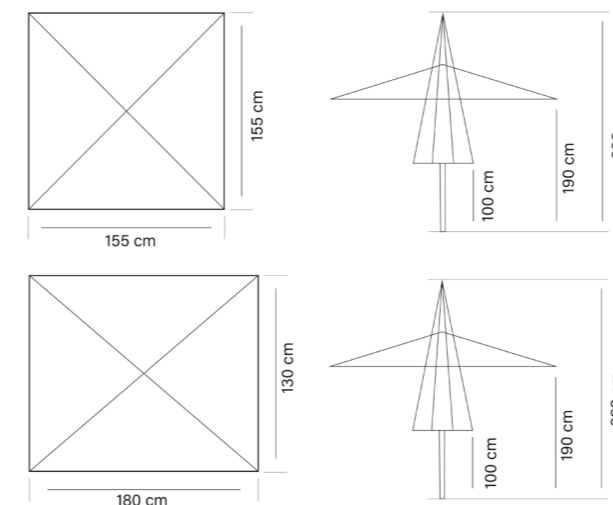

MONTURA DISPONIBLE / AVAILABLE STRUCTURE / STRUCTURE DISPONIBLE

■ Antracita

MÁSTIL / POLE / MÂT

Acero galvanizado / Galvanized steel / Mât acier Ø33-36 mm
Pared / Thickness / Épaisseur 0,7 mm

VARILLAS / RIBS / BALEINES

4 uds paragón acero galvanizado Ø8 mm

BASES COMPATIBLES* / COMPATIBLE BASES* / PIEDS COMPATIBLES*

HS20 - TH22 - TH30 - MP20

TEJIDOS DISPONIBLES / AVAILABLE FABRICS / TISSUS DISPONIBLES

Acrylic Basic Acrylic Masa Soft Olefin 190



Reforzado con cable interior
Reinforced with inner cable
Renforcé avec par un câble intérieur

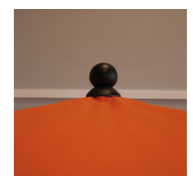

Terminal en PVC
PVC terminal
Boule décoration PVC

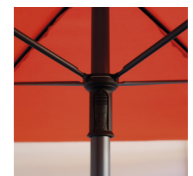

Sistema de apertura
Opening system
Système d'ouverture

*Elección de las bases en función de las condiciones del lugar de la instalación y bajo responsabilidad del cliente / *Choice of bases depending on the conditions of the place of installation and under the responsibility of the client / *Choix des bases en fonction des conditions du lieu de l'installation et sous la responsabilité du client



Cádiz, Andalucía (España)
888 | Parasol Arena 2x2 m

REF. 888

ARENA 2x2 m



Parasol con líneas rectas que facilita la creación de espacios uniformes. Salida de vientos.

Parasol with straight lines that facilitates the creation of uniform spaces. Wind exhaust.

Parasol aux lignes droites qui facilite la création d'espaces uniformes. Soufflet anti-vent.

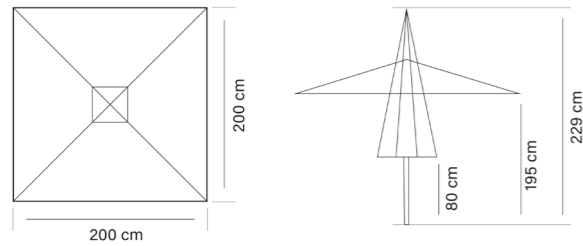

MONTURA DISPONIBLE / AVAILABLE STRUCTURE / STRUCTURE DISPONIBLE

Blanco

MÁSTIL / POLE / MÂT

Aluminio / Aluminum Ø38-35 mm
Pared / Thickness / Épaisseur 1 mm

VARILLAS / RIBS / BALEINES

4 uds en aluminio de 14x20 mm / 4 uds 14x20 mm aluminum
Pared / Thickness / Épaisseur Ø9 mm

BASES COMPATIBLES* / COMPATIBLE BASES* / PIEDS COMPATIBLES*

HS20 - TH22 - TH30 - MP20

TEJIDOS DISPONIBLES / AVAILABLE FABRICS / TISSUS DISPONIBLES

Acrylic Basic Acrylic Masa Soft Polyester Olefin 190



Ajustable a 3 alturas
3 height adjust
3 réglages de hauteur



Bisagras de PVC
PVC hinges
Charnières PVC



Mástil ocultable
Concealable pole
Mât coulissant



Madrid, España
892 | Parasol Arena Ø2,5 m

REF. 892

ARENA Ø2,5 m



Ideal para superficies con amplios espacios independientes. Salida de vientos.

Ideal for areas with large independent spaces. Wind exit.

Idéal pour les zones disposant de grands espaces indépendants. Sortie du vent.

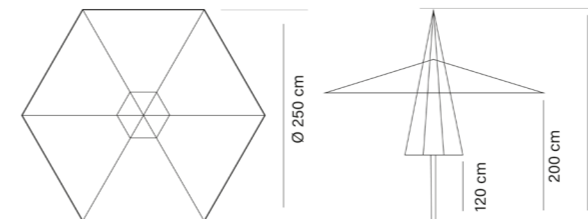

MONTURA DISPONIBLE / AVAILABLE STRUCTURE / STRUCTURE DISPONIBLE

Blanco

MÁSTIL / POLE / MÂT

Aluminio / Aluminum Ø38-35 mm
Pared / Thickness / Épaisseur 1 mm

VARILLAS / RIBS / BALEINES

6 uds en aluminio de 14x20 mm / 6 uds 14x20 mm aluminum
Pared / Thickness / Épaisseur Ø9 mm

BASES COMPATIBLES* / COMPATIBLE BASES* / PIEDS COMPATIBLES*

HS20 - TH22 - TH30 - MP20

TEJIDOS DISPONIBLES / AVAILABLE FABRICS / TISSUS DISPONIBLES

Acrylic Basic Acrylic Masa Soft Polyester Olefin 190

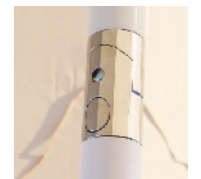

Inclinable
With tilt
Inclinable



Ajustable a 3 alturas
3 height adjust
3 réglages de hauteur

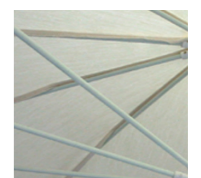

Bisagras de PVC
PVC hinges
Charnières PVC



Mástil ocultable
Concealable pole
Mât coulissant

Denia, Alicante (España)
875 | Parasol Vía 2x2 m



REF. 875

VIA 2x2 m



Parasol de aluminio reforzado con varillas redondas.

Reinforced aluminum parasol with round rods.

Parasol en aluminium renforcé avec des baleines rondes.

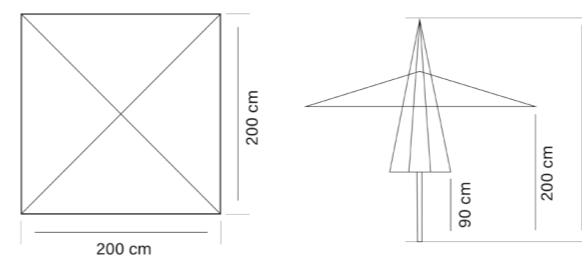

1 pieza / 1 pole / 1 Mât

MONTURA DISPONIBLE / AVAILABLE STRUCTURE / STRUCTURE DISPONIBLE

■ Gris plata

MÁSTIL / POLE / MÂT

Aluminio / Aluminum Ø38 mm
Pared / Thickness / Épaisseur 1,5 mm

VARILLAS / RIBS / BALEINES

4 uds aluminio de Ø19 mm / 4 uds aluminum Ø19 mm
Pared / Thickness / Épaisseur 1,2 mm

BASES COMPATIBLES* / COMPATIBLE BASES* / PIEDS COMPATIBLES*

HS20 - TH22 - TH30 - MP20

TEJIDOS DISPONIBLES / AVAILABLE FABRICS / TISSUS DISPONIBLES

Acrylic Basic Acrylic Masa Soft Polyester Olefin 190



Acabados ABS
ABS finishes
Pièces d'union en ABS



Acabado punta de varilla
Rod end finish
Fixation toile extrémité baleine

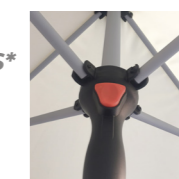

Sistema push up
Push up system
Système push-up

Palafrugell, Girona (España)
897 | Parasol Patio 2,5x2,5 m



REF. 897

PATIO 2,5x2,5 m



Parasol de medida muy versátil adaptable a todo los espacios.

Parasol of very versatile size adaptable to all spaces.

Parasol d'une taille très polyvalente, adaptable à tous les espaces.

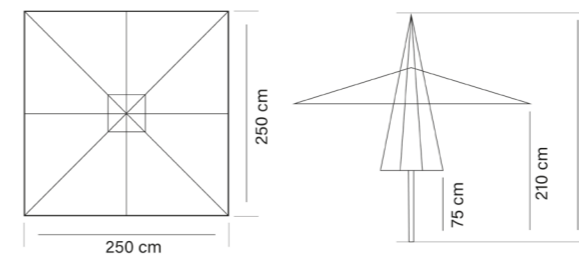

MONTURA DISPONIBLE / AVAILABLE STRUCTURE / STRUCTURE DISPONIBLE

Blanco

MÁSTIL / POLE / MÂT

Aluminio / Aluminum Ø48 mm
Pared / Thickness / Épaisseur 1 mm

VARILLAS / RIBS / BALEINES

8 uds aluminio de 14x20 mm / 8 uds 14x20 mm aluminum
Pared / Thickness / Épaisseur 0,5 mm
Salida de vientos / Wind exhaust / Soufflet anti-vent

BASES COMPATIBLES* / COMPATIBLE BASES* / PIEDS COMPATIBLES*

TH30 - TH137 - MP40 - HS40

TEJIDOS DISPONIBLES / AVAILABLE FABRICS / TISSUS DISPONIBLES

Acrylic Basic Acrylic Masa Soft Polyester Olefin 190



Sistema de apertura con doble polea y bloqueo de seguridad con pasador

Double pulley system with safety pin lock

Système de poulie double, avec goupille de sécurité



Freno de cuerda

Rope brake

Système de frein/blocage



Bisagras de PVC

PVC hinges

Charnières en PVC



REF. 885

ZOCO 2x3 m

Adaptable a terrazas con anchos limitados.

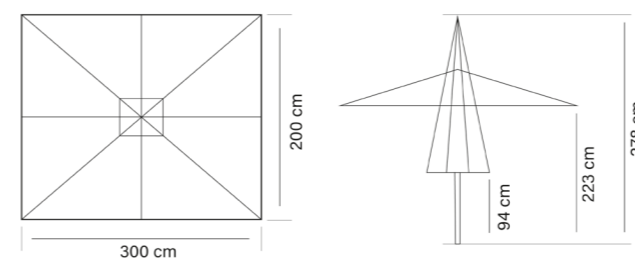
*Adaptable to terraces with limited widths.**Adaptable aux terrasses de largeur limitée.***MONTURA DISPONIBLE / AVAILABLE STRUCTURE / STRUCTURE DISPONIBLE** Blanco**MÁSTIL / POLE / MÂT**Aluminio / Aluminum Ø48 mm
Pared / Thickness / Épaisseur 1,2 mm**VARILLAS / RIBS / BALEINES**8 uds aluminio de 12x18mm / 8 uds 12x18mm aluminum
Pared / Thickness / Épaisseur 0,5 mm
Salida de vientos / Wind exhaust / Soufflet anti-vent**BASES COMPATIBLES* / COMPATIBLE BASES* / PIEDS COMPATIBLES***

TH30 - TH137 - MP40 - HS40

TEJIDOS DISPONIBLES / AVAILABLE FABRICS / TISSUS DISPONIBLES

Acrylic Basic Acrylic Masa Soft Polyester Olefin 190

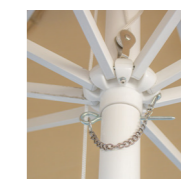

Sistema de apertura por polea y bloqueo de seguridad con pasador

*Pulley system with safety pin lock**Système de poulie, avec goupille de sécurité*



REF. 886

RUEDO Ø3 m

Parasol para crear espacios individuales.

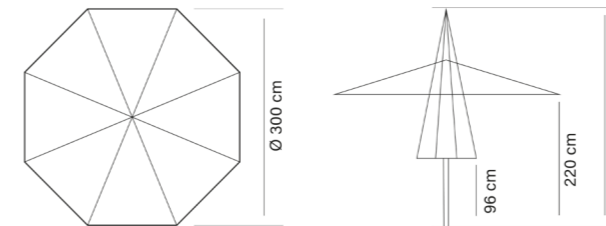
*Parasol to create individual spaces.**Parasol pour créer des espaces individuels.***MONTURA DISPONIBLE / AVAILABLE STRUCTURE / STRUCTURE DISPONIBLE**
 Blanco
MÁSTIL / POLE / MÂT
 Aluminio / Aluminum Ø48 mm
 Pared / Thickness / Épaisseur 1 mm
VARILLAS / RIBS / BALEINES
 8 uds aluminio de 14x20mm / 8 uds 14x20mm aluminum
 Pared / Thickness / Épaisseur 0,6 mm
 Salida de vientos / Wind exhaust / Soufflet anti-vent
ACCESORIOS / COMPLEMENTS / ACCESSOIRES

Funda F/XR-PL02

BASES COMPATIBLES* / COMPATIBLE BASES* / PIEDS COMPATIBLES*

TH30 - TH137 - MP40 - HS40

TEJIDOS DISPONIBLES / AVAILABLE FABRICS / TISSUS DISPONIBLES

Acrylic Basic Acrylic Masa Soft Polyester Olefin 190



Sistema de apertura por polea y bloqueo de seguridad con pasador

*Pulley system with safety pin lock**Système de frein/blocage*

Freno de la cuerda

*Rope brake**Frein à câble*

Madrid, España
898 | Parasol Plaza 3x3 m



Ibiza, España
898 | Parasol Plaza 3x3 m



REF. 898

PLAZA 3x3 m



Parasol en aluminio de líneas rectas, manejable y ligero.

Aluminium parasol of straight lines, handy and light.

Parasol en aluminium aux lignes droites, facile à manipuler et léger.

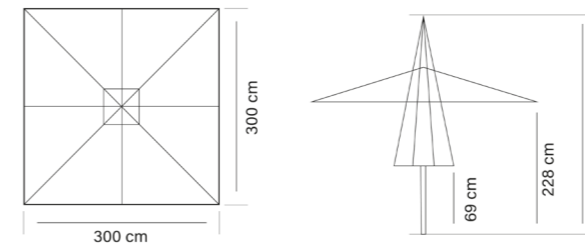

MONTURA DISPONIBLE / AVAILABLE STRUCTURE / STRUCTURE DISPONIBLE

Blanco

MÁSTIL / POLE / MÂT

Aluminio / Aluminum Ø48 mm
Pared / Thickness / Épaisseur 1 mm

VARILLAS / RIBS / BALEINES

8 uds aluminio de 14x20 mm / 8 uds 14x20 mm aluminum
Pared / Thickness / Épaisseur 0,9 mm
Salida de vientos / Wind exhaust / Soufflet anti-vent

ACCESORIOS / COMPLEMENTS / ACCESSOIRES

Funda F/XR-PL02

BASES COMPATIBLES* / COMPATIBLE BASES* / PIEDS COMPATIBLES*

TH30 - TH137 - MP40 - HS40 - GY30

TEJIDOS DISPONIBLES / AVAILABLE FABRICS / TISSUS DISPONIBLES

Acrylic Basic Acrylic Masa Soft Polyester Olefin 190



Sistema de apertura por polea y bloqueo de seguridad con pasador

Pulley system with safety pin lock

Système de poulie, avec goupille de sécurité



Bisagras de PVC
PVC hinges
Charnières en PVC



Freno de cuerda
Rope brake
Système de frein/blocage

REF. 876 | 887 | 899 | 895

HEAVY DUTY



Parasol reforzado de alto rendimiento y elegancia.
High performance and elegant reinforced sunshade.
 Parasol renforcé performant et élégant.



REF. 876
HEAVY DUTY Ø3 m

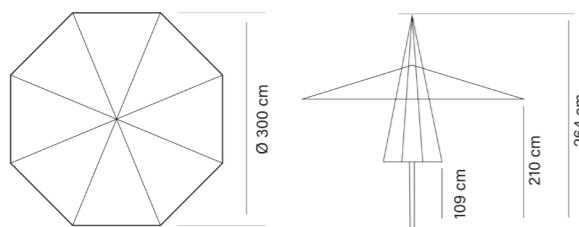

REF. 887
HEAVY DUTY 2x3 m

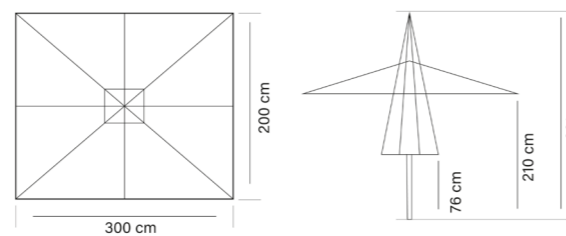
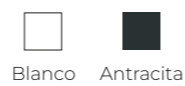

REF. 899
HEAVY DUTY 3x3 m

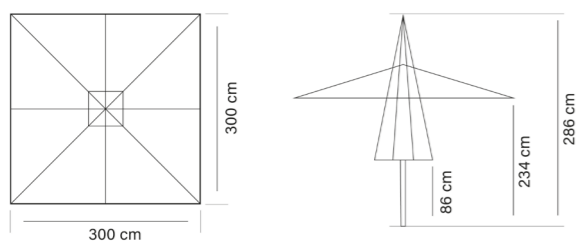

REF. 895
HEAVY DUTY 3,5x3,5 m

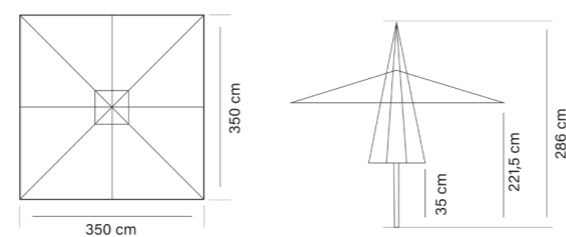

Jaén, Andalucía (España)
 895 | Parasol H.Duty 3,5x3,5 m

MONT. DISPONIBLE (SEGÚN MODELO) / AVAILABLE STRUCT. (ACCORDING TO MODEL) / STRUCT. DISPONIBLE (SELON LA DIMENSION)



MÁSTIL / POLE / MÂT

Aluminio / Aluminum 1 p Ø50 mm
 Pared / Tickness / Épaisseur 1,6 mm

VARILLAS / RIBS / BALEINES

8 uds aluminio de 20x30 mm / 8 uds 20x30 mm aluminum
 Pared / Tickness / Épaisseur 1,1 mm
 Salida de vientos / Wind exhaust / Soufflet anti-vent

ACCESORIOS / COMPLEMENTS / ACCESSOIRES

Calefactores, iluminación, canal de unión y funda F/XR-PC01

BASES COMPATIBLES* / COMPATIBLE BASES* / PIEDS COMPATIBLES*

MP40 - LTH50 - 50ET - 245 - CAJÓN MP01 - GY50 - GY70

TEJIDOS DISPONIBLES / AVAILABLE FABRICS / TISSUS DISPONIBLES

Acrylic Basic Acrylic Masa Soft Acrylic Masa Forte Polyester Olefin 190 Olefin 250



Unión de varilla reforzada
 Reinforced rib hinges
 Charnières renforcées



Puntas de tensión auto-ajustables
 Autoadjustable end tip, due to fabric stress
 Extrémités des baleines auto-ajustables



Freno de cuerda
 Rope brake
 Système de frein/blocage



Sistema de doble polea y bloqueo de seguridad con pasador
 Double pulley system and safety pin lock
 Système de poulie double avec goupille de sécurité.

*Elección de las bases en función de las condiciones del lugar de la instalación y bajo responsabilidad del cliente / *Choice of bases depending on the conditions of the place of installation and under the responsibility of the client / *Choix des bases en fonction des conditions du lieu de l'installation et sous la responsabilité du client

Alhambra, Granada (España)
899 | Parasol Heavy Duty 3x3 m



Alhambra, Granada (España)
899 | Parasol Heavy Duty 3x3 m





Madrid, España
899 | Parasol Heavy Duty 3x3 m



REF. 878

LATERAL 3x3 m



Parasol de mástil desplazado para conseguir espacio diáfanos con regulación abatible.

Parasol with displaced mast to achieve diaphanous with folding regulation.

Parasol avec mât décentré pour un gain de place.

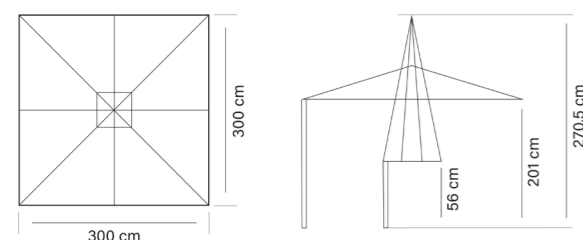

MONTURA DISPONIBLE / AVAILABLE STRUCTURE / STRUCTURE DISPONIBLE

Blanco



Cruzeta incluida, rotación de 360°
Losas de cemento no incluidas

*Cross included, with 360° rotation
Concrete slabs not included*

*Base croix incluse et rotation 360°
Dalles en option*

MÁSTIL / POLE / MÂT

Aluminio / Aluminum 1 p Ø65 mm
Pared / Thickness / Épaisseur 1,2 mm

VARILLAS / RIBS / BALEINES

8 uds aluminio de 14x20 mm / 8 uds 14x20 mm aluminum
Pared / Thickness / Épaisseur 0,9 mm
Salida de vientos / Wind exhaust / Soufflet anti-vent

ACCESORIOS / COMPLEMENTS / ACCESSOIRES

Calefactores, iluminación y funda F/XR-PL02

BASES COMPATIBLES* / COMPATIBLE BASES* / PIEDS COMPATIBLES*

4 losas CDLC30 - 4 losas DTH25

TEJIDOS DISPONIBLES / AVAILABLE FABRICS / TISSUS DISPONIBLES

Acrylic Basic Acrylic Masa Soft Polyester Olefin 190

*Elección de las bases en función de las condiciones del lugar de la instalación y bajo responsabilidad del cliente / *Choice of bases depending on the conditions of the place of installation and under the responsibility of the client / *Choix des bases en fonction des conditions du lieu de l'installation et sous la responsabilité du client

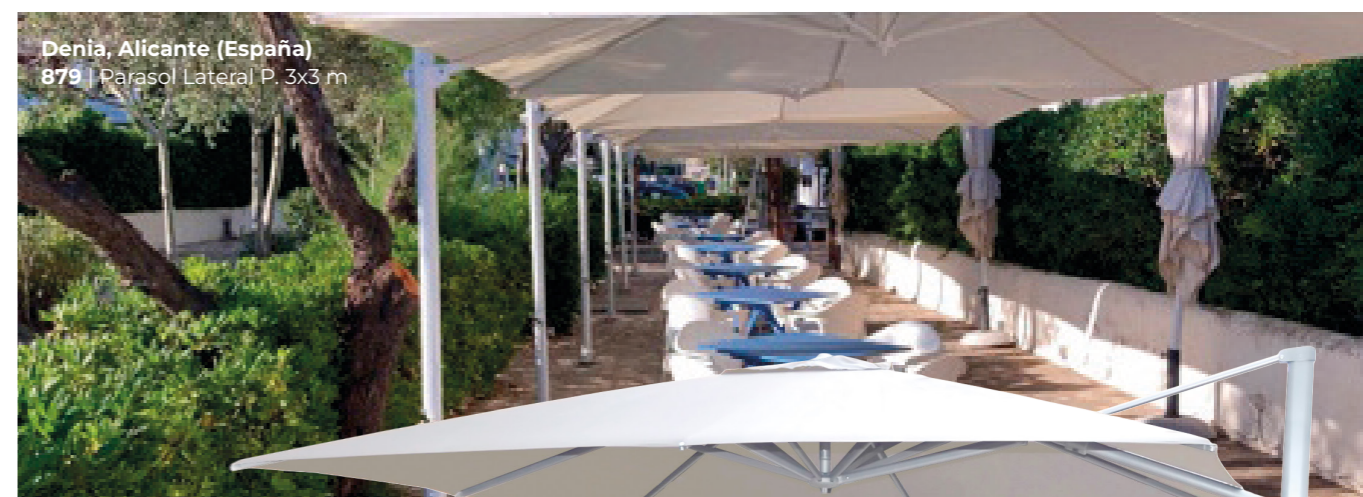

Denia, Alicante (España)
879 | Parasol Lateral P. 3x3 m

REF. 879

LATERAL PLUS 3x3 m



Parasol de mástil desplazado con alto rendimiento, reforzado en mástil y componentes. Regulación abatible.

High performance displaced mast parasol with reinforced mast and components. Folding regulation.

Parasol à mât déporté haute performance avec mât et composants renforcés. Réglage du pliage.

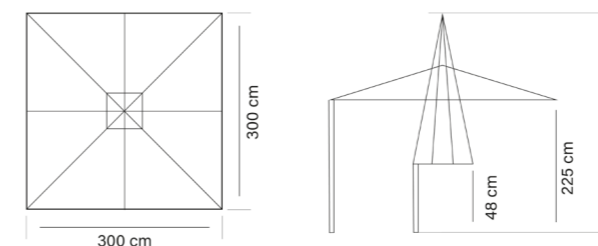

MONTURA DISPONIBLE / AVAILABLE STRUCTURE / STRUCTURE DISPONIBLE

Blanco Antracita



Cruzeta incluida, rotación de 360°
Losas de cemento no incluidas

*Cross included, with 360° rotation
Concrete slabs not included*

*Base croix incluse avec rotation 360°
Dalles en option*

MÁSTIL / POLE / MÂT

Aluminio / Aluminum 65x80 mm
Pared / Thickness / Épaisseur 2,5 mm

VARILLAS / RIBS / BALEINES

8 uds aluminio de 14x28 mm / 8 uds 14x28 mm aluminum
Pared / Thickness / Épaisseur 1,2 mm
Salida de vientos / Wind exhaust / Soufflet anti-vent

ACCESORIOS / COMPLEMENTS / ACCESSOIRES

Calefactores, iluminación y funda F/XR-PL02

BASES COMPATIBLES* / COMPATIBLE BASES* / PIEDS COMPATIBLES*

4 losas de CDLC30 - 4 losas DTH25

TEJIDOS DISPONIBLES / AVAILABLE FABRICS / TISSUS DISPONIBLES

Acrylic Basic Acrylic Masa Soft Polyester PU Olefin 190



Puntas de tensión autoajustables

Autoadjustable end tip, due to fabric stress

Extrémité des baleines autoajustables



Apertura con manivela extraíble

Opening with removable handle

Ouverture avec manivelle amovible

*Elección de las bases en función de las condiciones del lugar de la instalación y bajo responsabilidad del cliente / *Choice of bases depending on the conditions of the place of installation and under the responsibility of the client / *Choix des bases en fonction des conditions du lieu de l'installation et sous la responsabilité du client

REF. 889 | 884 | 894

MÁSTER



Parasol robusto idóneo para instalaciones permanentes.

Robust parasol suitable for permanent installations.

Parasol robuste adapté pour installations fixes.



1 pieza / 1 pole / 1 Mât

REF. 889
MÁSTER 3x3 m

Blanco Antracita

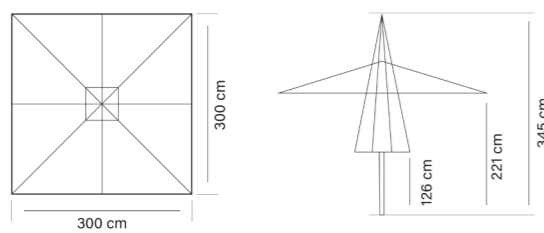

REF. 884
MÁSTER 3x4 m

Blanco Antracita

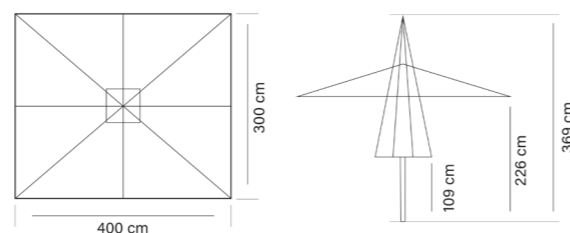

REF. 894
MÁSTER 4x4 m

Blanco Antracita

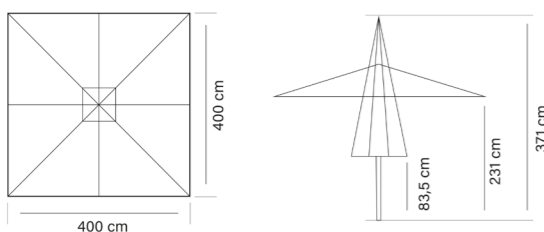

Zaragoza, Aragón (España)
894 | Parasol Máster 4x4 m



Mas la Ferreria, Girona (España)
889 | Parasol Máster 3x3 m

MONTURA DISPONIBLE / AVAILABLE STRUCTURE / STRUCTURE DISPONIBLE

Blanco Antracita

MÁSTIL / POLE / MÂT

Aluminio / Aluminum 71x71 mm
Pared / Thickness / Épaisseur 3,1 mm

VARILLAS / RIBS / BALEINES

8 uds aluminio de 20x35 mm / 8 uds 20x35 mm aluminum
Pared / Thickness / Épaisseur 1,5 mm
Salida de vientos / Wind exhaust / Soufflet anti-vent

ACCESORIOS / COMPLEMENTS / ACCESOIRES

Calefactores, iluminación, canal vierteaguas, cortinas y funda F/894P30

BASES COMPATIBLES* / COMPATIBLE BASES* / PIEDS COMPATIBLES*

SHBC+4 loseta - ET70 - 245-90 - Cajón MP01

TEJIDOS DISPONIBLES / AVAILABLE FABRICS / TISSUS DISPONIBLES

Acrylic Masa Forte Polyester PU Olefin 250



Punta y enganche reforzados.
Reinforced rib end tip fabric attachment.
Fixation renforcée de la toile.



Mástil cuadrado con cantos redondeados. Manivela extraíble.
Square pole with rounded corners. Detachable crank.
Mât carré aux angles arrondis. Manivelle amovible.



Varilla interior de refuerzo.
Inner reinforcement.
Baleine intérieure de renort au niveau de unions.



Apertura telescópica / 4 varillas de refuerzo
Telescopic open system / 4 added ribs.
Système d'ouverture télescopique / Triples baleines

*Elección de las bases en función de las condiciones del lugar de la instalación y bajo responsabilidad del cliente / *Choice of bases depending on the conditions of the place of installation and under the responsibility of the client / *Choix des bases en fonction des conditions du lieu de l'installation et sous la responsabilité du client



Navarra, España

894 | Parasol Máster 4x4 m





Zaragoza, España
894 | Parasol Máster 4x4 m

REF. 864 | 865

GIANT



Parasol gigante con doble refuerzo en tramo de unión.

Giant parasol with double reinforcement in the joint section.

Parasol géant avec double renfort au niveau de la section d'union des baleines.



REF. 864
GIANT 4x4 m

Blanco Antracita

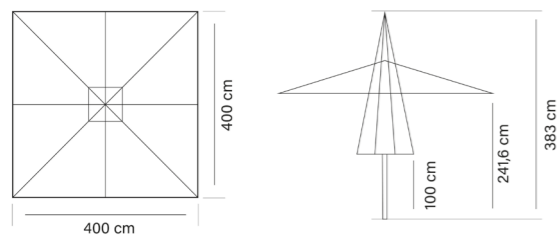

REF. 865
GIANT 5x5 m

Blanco Antracita

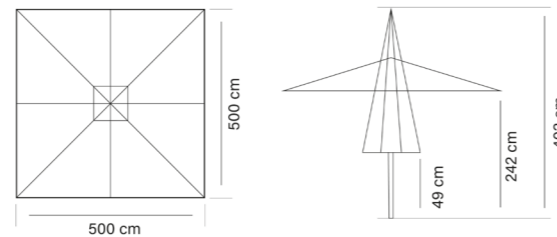

Palafrugell, Girona (España)
865 | Parasol Giant 5x5 m



Cassà de la Selva, Girona (España)
865 | Parasol Giant 5x5 m

MONTURA DISPONIBLE / AVAILABLE STRUCTURE / STRUCTURE DISPONIBLE



Blanco Antracita

MÁSTIL / POLE / MÂT

Aluminio / Aluminum Ø86 mm
Pared / Thickness / Épaisseur 2,5 mm

VARILLAS / RIBS / BALEINES

8 uds aluminio de 20x35 mm / 8 uds 20x35 mm aluminum
Pared / Thickness / Épaisseur 2 mm
Refuerzo interior / Inner reinforcement / Renfort intérieur

ACCESORIOS / COMPLEMENTOS / ACCESSOIRES

Calefactores, iluminación, canal vierteaguas, cortinas y funda F/865P30

BASE INCLUIDA* / INCUDES BASE* / PIED INCLUS*

Acople metálico de fijación, con tapa / Fixing metal coupling included, with cover cap / Pied à fixer au sol inclus



TEJIDOS DISPONIBLES / AVAILABLE FABRICS / TISSUS DISPONIBLES

Acrylic Masa Forte Polyester PU Olefin 250



Sistema de apertura telescópico.
Telescopic open system.
Système d'ouverture télescopique.



Mecanismo con cremallera metálica.
Metal zipper mechanism.
Crémaillère en métal



Manivela extraíble.
Detachable crank.
Manivelle amovible.



Base empotrable opcional con bisagra para montaje.
Optional recessed base with mounting hinge.
Pied encastrable en option

*Elección de las bases en función de las condiciones del lugar de la instalación y bajo responsabilidad del cliente / *Choice of bases depending on the conditions of the place of installation and under the responsibility of the client / *Choix des bases en fonction des conditions du lieu de l'installation et sous la responsabilité du client



Barcelona, España
864 | Parasol Giant 4x4 m

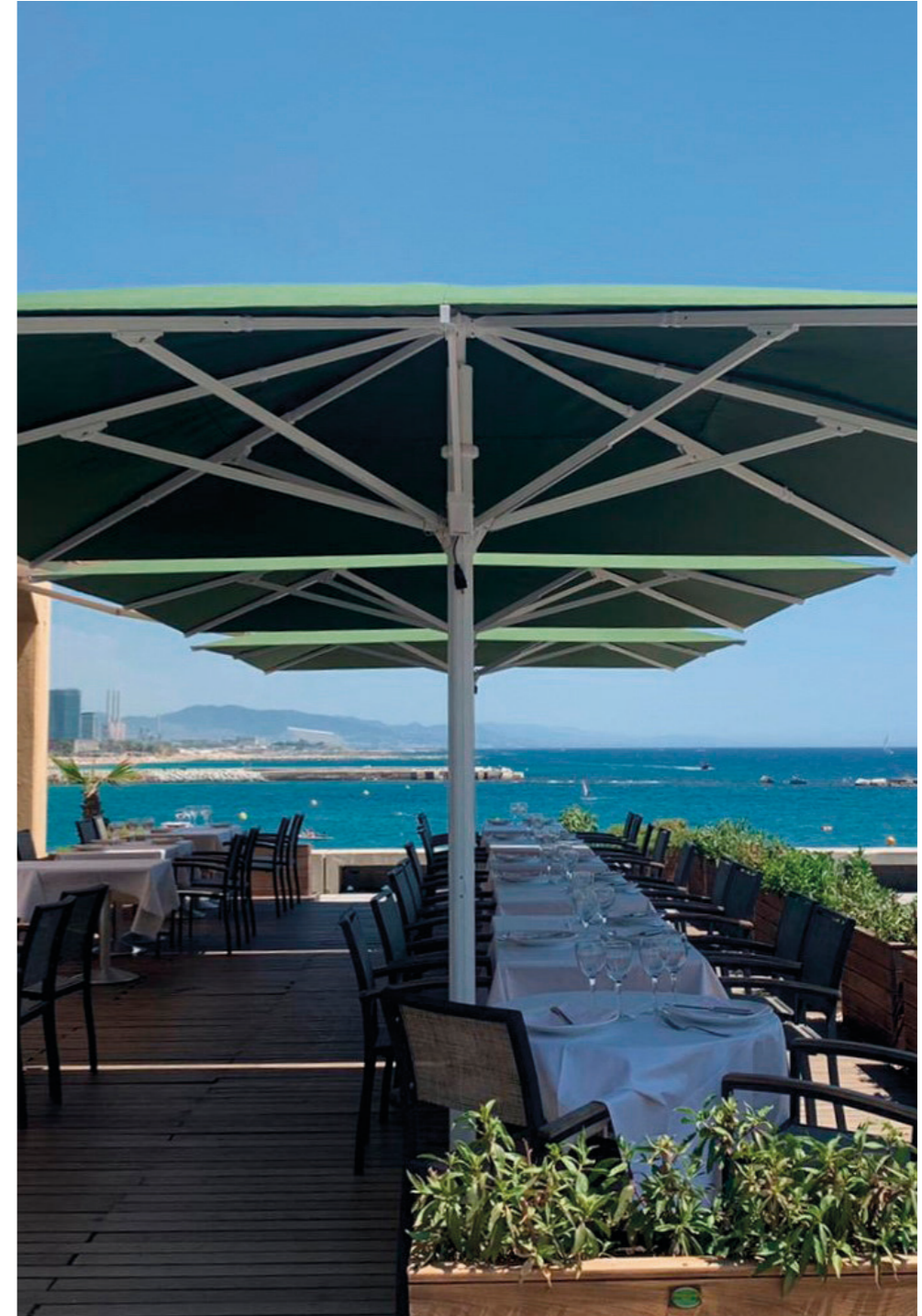



Palafrugell, Girona (España)
865 | Parasol Giant 5x5 m

REF. 841 | 842 | 843 | 844

MADERA PLUS



Parasoles fabricados con madera de eucalipto grandis

Parasols made of eucalyptus grandis wood

Parasols en bois d'eucalyptus grandis



1 pieza / 1 pole / 1 Mât

REF. 841
MADERA Ø2 m

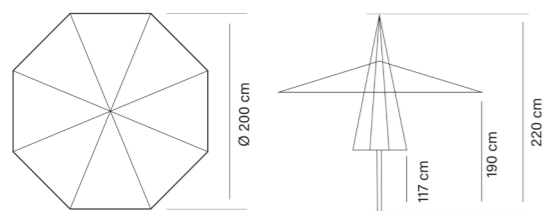

REF. 843
MADERA Ø3 m

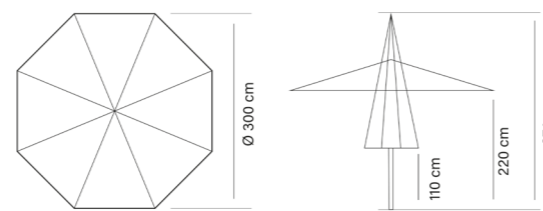

REF. 842
MADERA 2x2 m

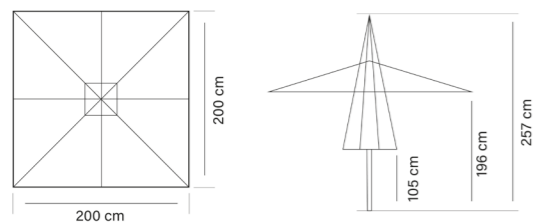

REF. 844
MADERA 3x3 m

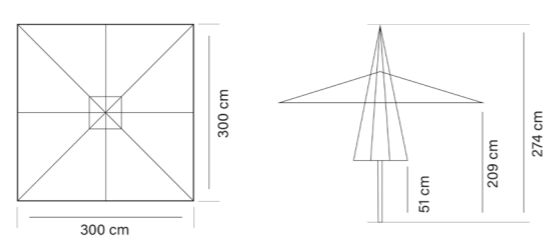

Formentera, España
844 | Parasol Madera 3x3 m



Palafrugell, Girona (España)
841 | Parasol Madera Ø2 m

MONTURA DISPONIBLE / AVAILABLE STRUCTURE / STRUCTURE DISPONIBLE



Bloqueo con pasador de seguridad
Safety pin lock
Goupille de sécurité

MÁSTIL / POLE / MÂT

841: Ø38 mm
842: Ø48 mm
843: Ø48 mm
844: Ø48 mm



Terminal en forma de punta
Terminal in the form of a tip
Boule décoration bois

VARILLAS / RIBS / BALEINES

841: 8 uds de 17x22 mm
842: 8 uds de 20x28 mm
843: 8 uds de 20x28 mm
844: 8 uds de 20x28 mm

ACCESORIOS / COMPLEMENTS / ACCESSOIRES

Funda F/XR-PC01

BASES COMPATIBLES* / COMPATIBLE BASES* / PIEDS COMPATIBLES*

TH30 - TH137 - MP40 - HS40

TEJIDOS DISPONIBLES / AVAILABLE FABRICS / TISSUS DISPONIBLES

Acrylic Basic Acrylic Masa Soft Polyester Olefin 190

*Elección de las bases en función de las condiciones del lugar de la instalación y bajo responsabilidad del cliente / *Choice of bases depending on the conditions of the place of installation and under the responsibility of the client / *Choix des bases en fonction des conditions du lieu de l'installation et sous la responsabilité du client



Formentera, España
844 | Parasol Madera 3x3 m

Barcelona, España

Vinilo | Frankfurt's Fabra i puig



Zaragoza, España
Serigrafía | Kiosco Nolasco



ESTAMPACIÓN

STAMPING / PERSONNALISATION

Serigrafía: Aplicación de tinta con pantalla sobre la pieza a estampar, a través de un proceso de emulsión y grabado / *Screen printing: Application of ink with screen on the piece to be stamped, through a process of emulsion and engraving* / Sérigraphie: Application de l'encre via un pochoir sur la pièce à imprimer, par un procédé d'émulsion et de gravure.

Vinilo: Adhesivo plástico fijado a la pieza a estampar mediante calor / *Vinyl: Plastic adhesive fixed to the part to be stamped by means of heat* / Vinyl adhésif fixé sur la toile à personnaliser via thermosoudure

PANTALLA SERIGRAFIA / SCREEN PRINTING / CLICHÉ SÉRIGRAPHIE

Pequeña / Small / Petit
25x30 cm

Mediana / Medium / Moyen
25x55 cm

Grande / Big / Grand
25x80 cm

LOGO

LOGO

LOGO

Barcelona, España
Serigrafía | La alcoba azul



Serigrafía | Grosso Napoletano



Saint Jean de Fos, Francia

Cerramiento parasol



CERRAMIENTOS

ENCLOSURES / RIDEAUX

Cortina universal para parasoles, de medida estándar en 2,3,4, y 5 m de ancho. Con doble perfil de aluminio, superior e inferior con faldón. Medidas especiales.

Universal curtain for sunshades, standard sizes in 2,3,4, and 5 m wide. With double aluminum profile, upper and lower with skirt. Special sizes.

Rideau pare-soleil universel, dimensions standard en 2, 3, 4 et 5 m de largeur. Avec double raidisseur en aluminium, supérieur et inférieur. Bavette incluse. Autres dimensions possibles.



Alta transparencia
High transparency
Haute transparence



Consultar medidas especiales
Consult special sizes
Tailles spéciales sur demande



TEJIDOS DISPONIBLES / AVAIBLE FABRICS / TISSUS DISPONIBLES

PVC transparente + PVC color
PVC transparente + Acrylic Masa Forte
PVC transparente + Olefin



CANAL VIERTEAGUAS

RAIN GUTTER / GOUSSIÈRES

El canal vierteaguas es adaptable a parasoles estándar de 2,3,4 y 5 metros. Medidas especiales. Este canal une los parasoles y evita que el agua de la lluvia caiga entre ambos, incluye perfiles y herrajes para su montaje.

The rain gutter is adaptable to standard sunshades of 2,3,4 and 5 meters. Special sizes.

This gutter joins the parasols and prevents rainwater from falling between them, includes profiles and hardware for assembly.

La gouttière est adaptable aux parasols standards de 2,3,4 et 5 mètres. Autres dimensions possibles.

Cette gouttière relie les parasols et empêche l'eau de passer au milieu. Sont inclus les raidisseurs et la visserie pour le montage.

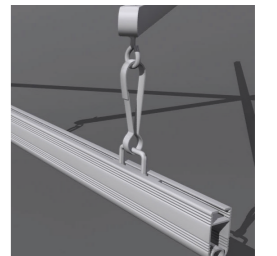

Herrajes de montaje incluidos
Assembly hardware included
Visserie incluse

MEDIDAS / SIZES / DIMENSIONS

Ancho estándar 34/48 cm para: 2,3,4 y 5 m

Standard width 34/48 cm for: 2,3,4 and 5 m

Dimension (largeur standard 34/48): 2,3,4 et 5 m

SUJECCIÓN / MOUNTING / FIXATION

Mediante perfiles de aluminio + herrajes

By aluminum profiles + hardware

Raidisseurs en aluminium + mousquetons

TEJIDOS DISPONIBLES / AVAIBLE FABRICS / TISSUS DISPONIBLES

Acrylic Masa Forte **Olefin** PVC



Consultar medidas especiales
Consult special sizes
Tailles spéciales sur demande

02 BASES

CEMENTO, RESINA, PPP, PLANCHA Y EMPOTRABLE

ALVAREZ VENTURA ALVAREZ VENTURA ALVAREZ VENTURA ALVAREZ VENTURA

CEMENTO PINTADO

CONCRETE PARASOL BASES / PIEDS DE PARASOL CIMENT



REF. TH11



REF. TH22



REF. TH30



REF. TH137



REF. LTH50



REF. MV50N



REF. GY

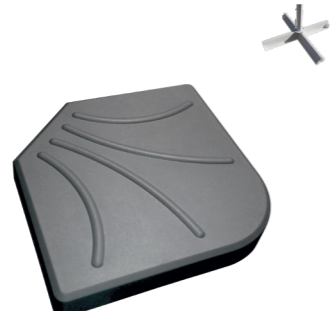

REF. DTH25

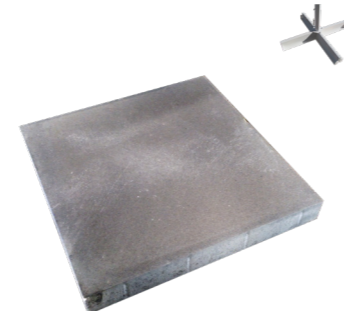

REF. CDLC30

ref	material material matériau	peso weight poids	medida measure dimensions	margen tubo Ø tube range Ø pour mâts Ø
TH11	Cemento	11 kg	36x26x6/30 cm	Ø30-38 mm
TH22	Cemento	22 kg	Ø48x5,5 cm	Ø38-48 mm
TH30	Cemento	30 kg	50x50x7/34 cm	Ø38-48 mm
DTH25	Cemento	25 kg	47x47x7 cm	-
CDLC30	Cemento no pintado	30 kg	50x50x5 cm	-
TH137	Cemento	37 kg	50x50x14/44 cm	Ø38-48 mm
LTH50	Cemento	50 kg	54x54x8/36 cm	Ø40-58 mm
MV50N	Cemento	50 kg	57x57x7 cm	Ø25-50 mm
GY	Cemento	20 kg 30 kg 50 kg 70 kg	57x52x12,5 cm 59,5x57x13 cm 68x65x19 cm 75,5x73,5x20 cm	Ø35-48 mm Ø35-48 mm Ø38-58 mm Ø38-58 mm

CEMENTO CON CARCASA DE RESINA / PPP

CONCRETE BASES WITH RESIN CASE AND PPP / PIEDS EN CIMENT RECOUVERT DE RÉSINE ET PPP



REF. HS40

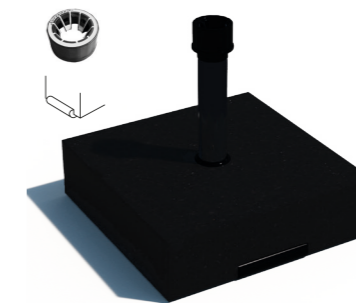

REF. HSN40



REF. HS15 / HS20



REF. MV21



REF. MV39



ref	material material matériau	peso weight poids	medida measure dimensions	margen tubo Ø tube range Ø pour mâts Ø
HS40	Cemento con carcasa de resina	40 kg	40x40x13/33 cm	Resina Ø21-54 mm
HSN40	Cemento con carcasa de resina	40 kg	40x40x13/33 cm	Aluminio Ø21-54 mm
HS15	Cemento con carcasa de resina	15 kg	Ø40x9 cm	Ø21-35 mm
HS20	Cemento con carcasa de resina	20 kg	Ø40x12 cm	Ø21-54 mm
MV21	PPP	21 kg	Ø43x8 cm	Ø18-53 mm
MV39	PPP	39 kg	54x47x9 cm	Ø18-53 mm

Zaragoza, España
Basecajón BASEMP01M/R



METÁLICAS

METAL BASES / PIEDS MÉTALLIQUES



REF. MP20 / MP40



REF. 245 / 245-90



REF. SHBC



REF. 50ET / 70ET

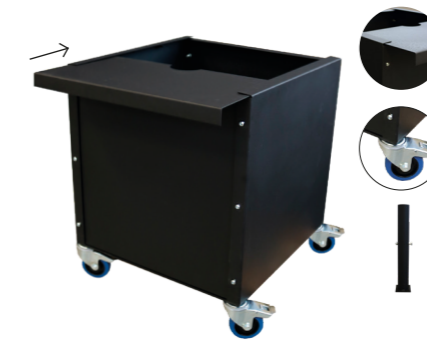

REF. MPBASE01MR

ref	material material matériau	tipo type type	peso weight poids	medida measure dimensions	margen tubo Ø tube range Ø pour mâts Ø
MP20	Hierro pintado con pintura electroestática (epoxy)	Plancha	20 kg	60x60x1/31 cm	Ø40 mm
MP40	Hierro pintado con pintura electroestática (epoxy)	Plancha	40 kg	60x60x1/31 cm	Ø50 mm
245	Hierro pintado con pintura electroestática (epoxy)	Fijar	7,22 kg	25x25x1/50 cm	hasta Ø50 mm
245-90	Hierro pintado con pintura electroestática (epoxy)	Fijar	8,18 kg	25x25x1/50 cm	hasta Ø90 mm
SHBC	Hierro pintado con pintura electroestática (epoxy)	Cruz	14 kg	97x97x6 cm	Mástil Máster (71x71mm)
50ET	Hierro pintado con pintura oxidon	Empotrable	3 kg	12x10x4/29 cm	Ø48-Ø50 mm
70ET	Hierro pintado con pintura oxidon	Empotrable	4 kg	12x10x4/29 cm	Ø65 mm (MÁSTER)
BASEMP01M/R	Hierro con pintura poliéster exterior	Jardinera metálica	58 kg	63x63x3 cm	Mástil Máster y Giant (71x71mm)

A close-up photograph of modern outdoor furniture. The scene features a white-painted metal frame with horizontal slats, supporting dark grey fabric cushions. A matching white metal table is partially visible on the right. The background shows a gravel surface and a concrete floor. The text '03 MOBILIARIO' is overlaid in the upper right, and 'ALUMINIO Y MADERA' is at the bottom right.

03
MOBILIARIO

ALUMINIO Y MADERA



Madrid, España
Conjunto mobiliario aluminio

MUEBLES FURNITURE / MOBILIER



REF. CHAV2B
SOFÁ CON BRAZOS (2 PLZ)

135x76x65 cm
42,8 kg
149x83x99 cm



REF. CHAV2SB
SOFÁ SIN BRAZOS (2 PLZ)

135x76x65/30 cm
36,6 kg
135x83x68,5 cm



REF. CHAV1
SILLÓN CON BRAZOS (1 PLZ)

70x76x65/30 cm
24,8 kg
84x84x70 cm



REF. CHAV1SB
SILLÓN SIN BRAZOS (1 PLZ)

75x76x66 cm
24,4 kg
86x71,5x70 cm



REF. CHAV1R
RINCONERA

76x76x66 cm
28,2 kg
83x83x68,5 cm

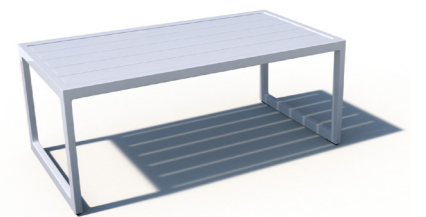

REF. CHAV90
MESA

90x48x44 cm
5,5 kg
91,5x49,5x45,5 cm

ACCESORIOS / COMPLEMENTS / COMPLÉMENTAIRES

Funda de protección / Protection cover / Housses de protection

TEJIDOS DISPONIBLES / AVAIBLE FABRICS / TISSUS DISPONIBLES

Acrylic Basic Acrylic Masa Soft Nautic Class Nautic Bio Plus Nautic Melange

Malgrat de Mar, España
CBRAL-X150 | Cama Balinesa Aluminio



CAMA BALINESA RECLINABLE

RECLINING BALINESE BED / LIT BALDAQUIN INCLINABLE



COLCHÓN / MATTRESS / MATELAS

150x200x10 cm
Densidad 25 kg/m³
Tejido náutico, base Textilene
Respaldos independientes reclinables / *Independently reclining backrests / Dossiers indépendents inclinables*

CORTINAS / CURTAINS / RIDEAUX

8 cortinas y techo en tejido acrílico drálon / *8 curtains and ceiling in dralon acrylic fabric / 8 rideaux et toiture en tissu acrylique dralon*

ACCESORIOS / COMPLEMENTS / COMPLÉMENTAIRES

Funda de protección / *Protection cover / Housses de protection*

TEJIDOS DISPONIBLES / AVAIBLE FABRICS / TISSUS DISPONIBLES

Acrylic Basic Acrylic Masa Soft Nautic Class Nautic Bio Plus
Nautic Melange

REF. CBRAL-X150

150x200x200 cm

90 kg

154x204x35 cm

CAMASTRO RECLINABLE

DUAL RECLINING SUNBED / TRANSAT DOUBLE INCLINABLE

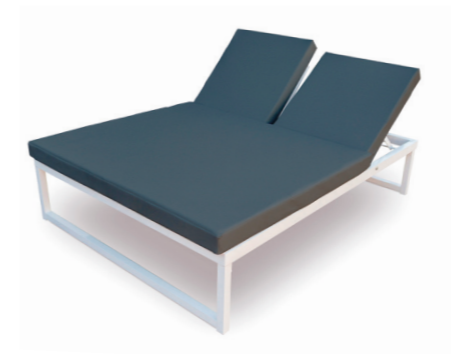

COLCHÓN / MATTRESS / MATELAS

150x200x10 cm
Densidad 25 kg/m³
Tejido náutico, base Textilene.
Respaldos independientes reclinables / *Independently reclining backrests / Dossiers indépendents inclinables*

ACCESORIOS / COMPLEMENTS / COMPLÉMENTAIRES

Funda de protección / *Protection cover / Housses de protection*

TEJIDOS DISPONIBLES / AVAIBLE FABRICS / TISSUS DISPONIBLES

Acrylic Basic Acrylic Masa Soft Nautic Class Nautic Bio Plus
Nautic Melange

REF. CMRAL150

150x200x41 cm

60 kg

153x203x38 cm

Pollença, Mallorca (España)
 Conjunto madera autoclave



MUEBLES
 FURNITURE / MOBILIER



REF. CHSL1
SILLÓN (1 PLZ)

▣ 60x74x75/34 cm
 ⚖ 13 kg
 📦 60x70x12 cm



REF. CHSL1R
RINCONERA

▣ 74x74x75/34 cm
 ⚖ 18 kg
 📦 70x70x19 cm



REF. CHSL2
SOFÁ (2 PLZ)

▣ 120x73,5x75/34 cm
 ⚖ 21 kg
 📦 70x120x12 cm



REF. CHSL45
MESA CUADRADA

▣ 45x45x34 cm
 ⚖ 8 kg
 📦 45x45x9 cm



REF. CHSL4590
MESA RECTANGULAR

▣ 90x45x34 cm
 ⚖ 12 kg
 📦 45x90x9 cm

ACCESORIOS / COMPLEMENTS / COMPLÉMENTAIRES

Funda de protección / Protection cover / Housses de protection

TEJIDOS DISPONIBLES / AVAILABLE FABRICS / TISSUS DISPONIBLES

Acrylic Basic Acrylic Masa Soft Nautic Class Nautic Bio Plus Nautic Melange



Pollença, Mallorca (España)
Conjunto madera autoclave

Sant Aniol de Finestres, Girona (España)
CHSL200 | Tumbona madera

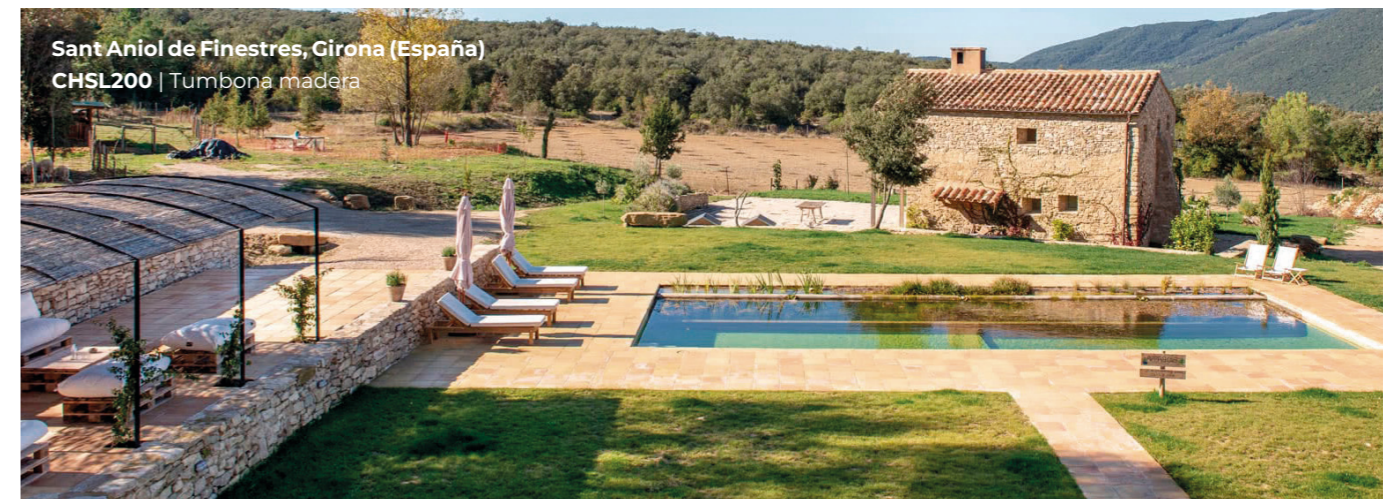
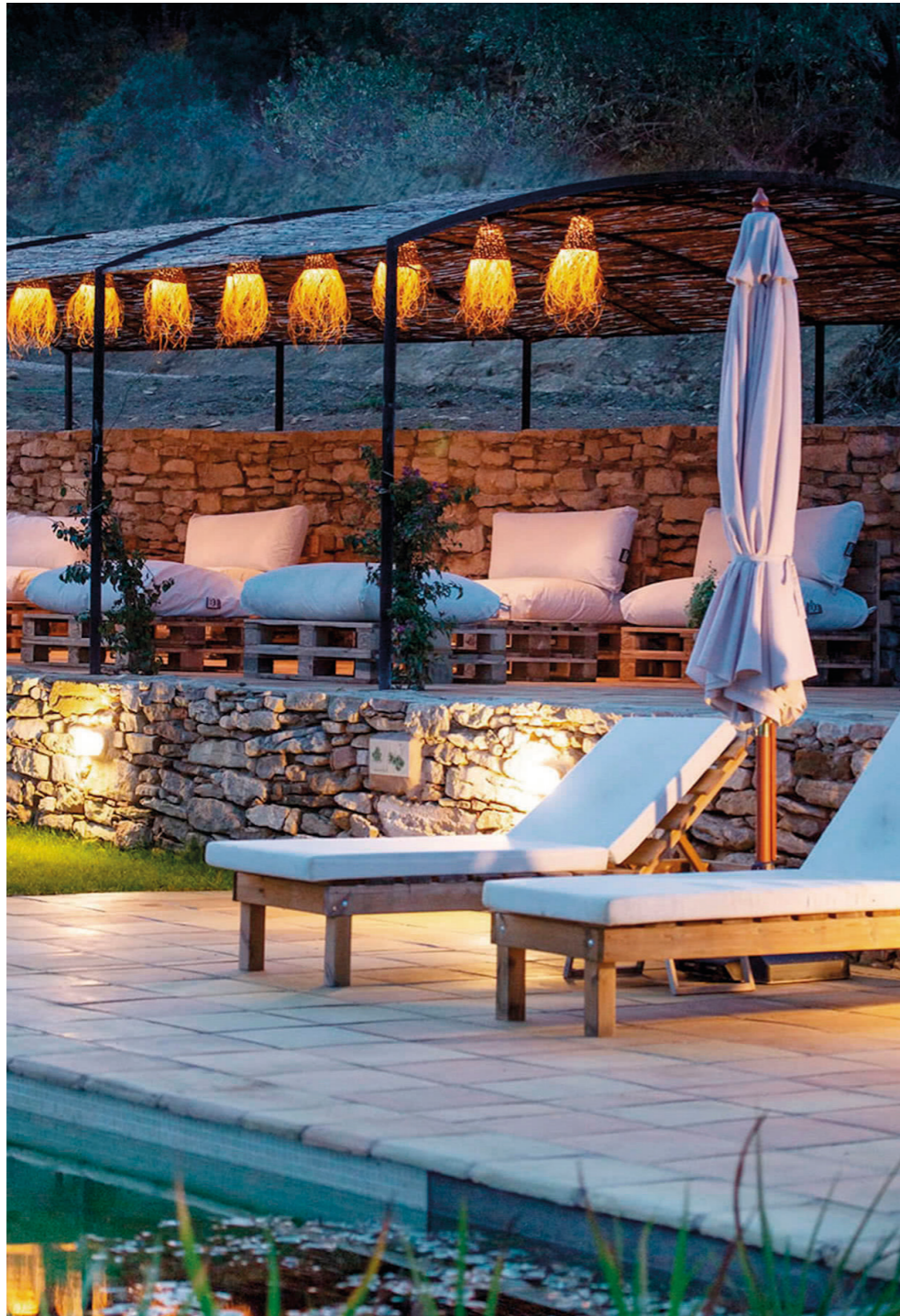

TUMBONAS SUNBED/TRANSATS

Estructura de madera en pino autoclave con respaldo reclinable. Colchón de espuma densidad de 25kg/m³ y fundas con tejido mixto (superior Náutico e inferior Textilene).

Autoclaved pine wood structure with reclining backrest. Foam mattress density 25kg/m³ and covers with mixed fabric (upper Nautical and lower Textilene).

Structure en bois de pin autoclavé avec dossier inclinable. Matelas en mousse de 25kg/m³ de densité et housses en tissu mixte (supérieur Nautic et inférieur Textilene).



REF. CHSL200
TUMBONA

📏 60x200x34 cm
⚖️ 21 kg
📦 200x60x25 cm



REF. CMR150
TUMBONA DOBLE

📏 125,5x200x40,5 cm
⚖️ 94 kg
📦 154,5x200x12 cm



REF. CHSL6070
RESPALDO RECLINABLE

📏 60x70 cm
⚖️ 8 kg

COLCHÓN / MATTRESS / MATELAS

Densidad 25 kg/m³
Tejido náutico, base Textilene

ACCESORIOS / COMPLEMENTS / COMPLÉMENTAIRES

Funda de protección / Protection cover / Housses de protection

TEJIDOS DISPONIBLES / AVAIBLE FABRICS / TISSUS DISPONIBLES

Acrylic Basic Acrylic Masa Soft Nautic Class Nautic Bio Plus Nautic Melange

Alicante, España

CBB150 | Cama Balinesa Fija



CAMA BALINESE FIJA

FIXED BALINESE BED / LIT BALDEQUIN FIXE



REF. CBB150

 168,5x200x207 cm

 125 kg

COLCHÓN / MATTRESS / MATELAS

75x200x15 cm (2 uds)
 Densidad 25 kg/m³
 Tejido náutico, base Textilene

CORTINAS / CURTAINS / RIDEAUX

8 cortinas y techo en acrílico con velcro / 8 acrylic curtains and ceiling with velcro / 8 rideaux et toiture en acrylique avec velcro

ACCESORIOS / COMPLEMENTS / ACCESSOIRES

Funda de protección / Protection cover / Housses de protection

INCLUYE / INCLUDES / INCLUS

1 Funda unión colchones: Tejido náutico, con ajuste en las esquinas
 2 almohadas de 75x60 cm

TEJIDOS DISPONIBLES / AVAIBLE FABRICS / TISSUS DISPONIBLES

Nautic Class **Nautic Bio Plus**

CAMA BALINESE RECLINABLE

RECLINABLE BALINESE BED / LITS BALDEQUIN INCLINABLE



REF. CBR150

 168,5x200x207 cm

 115 kg

COLCHÓN / MATTRESS / MATELAS

150x200x10 cm
 Densidad 25 kg/m³
 Tejido náutico, base Textilene
 Respaldos independientes reclinables / Independently reclining backrests /
 Dossiers indépendents inclinables

CORTINAS / CURTAINS / RIDEAUX

8 cortinas en acrílico con velcro / 8 acrylic curtains with velcro / 8 rideaux en acrylique avec velcro

ACCESORIOS / COMPLEMENTS / ACCESSOIRES

Funda de protección / Protection cover / Housses de protection

TEJIDOS DISPONIBLES / AVAIBLE FABRICS / TISSUS DISPONIBLES

Nautic Class **Nautic Bio Plus**

04 COJINES



PUFS, DECORATIVOS, TUMBONA



PUF

BEANBAG / POUFS



REF. PF111

☒ 135x105 cm



REF. PF1112

☒ 135x175 cm



REF. PF1113

☒ 110x80x70 cm



REF. PF1114

☒ 80x70x65 cm

RELLENO / FILLING / GARNITURE

Perlas de poliestireno expandido (EPS) / Expanded polystyrene beads (EPS) / Billes de polystyrène expansé (EPS)

TEJIDOS DISPONIBLES / AVAIBLE FABRICS / TISSUS DISPONIBLES

Acrylic Basic Acrylic Masa Soft Nautic Class Nautic Bio Plus Nautic Melange



CUADRANTES DECORATIVOS

DECORATIVE PILLOWS / COUSSINS OREILLERS PASSEPARTOUT



REF. RECTANGULAR

☒ 30x50 cm
60x40 cm
60x75 cm



REF. RULO

☒ Ø20x60 cm



REF. CUADRANTE

☒ 40x40 cm
45x45 cm
50x50 cm
55x55 cm
60x60 cm

RELLENO / FILLING / GARNITURE

Funda interior y fibra / Inner sheath and fiber / Gaine intérieure et fibre

TEJIDOS DISPONIBLES / AVAIBLE FABRICS / TISSUS DISPONIBLES

Acrylic Basic Acrylic Masa Soft Nautic Class Nautic Bio Plus Nautic Melange

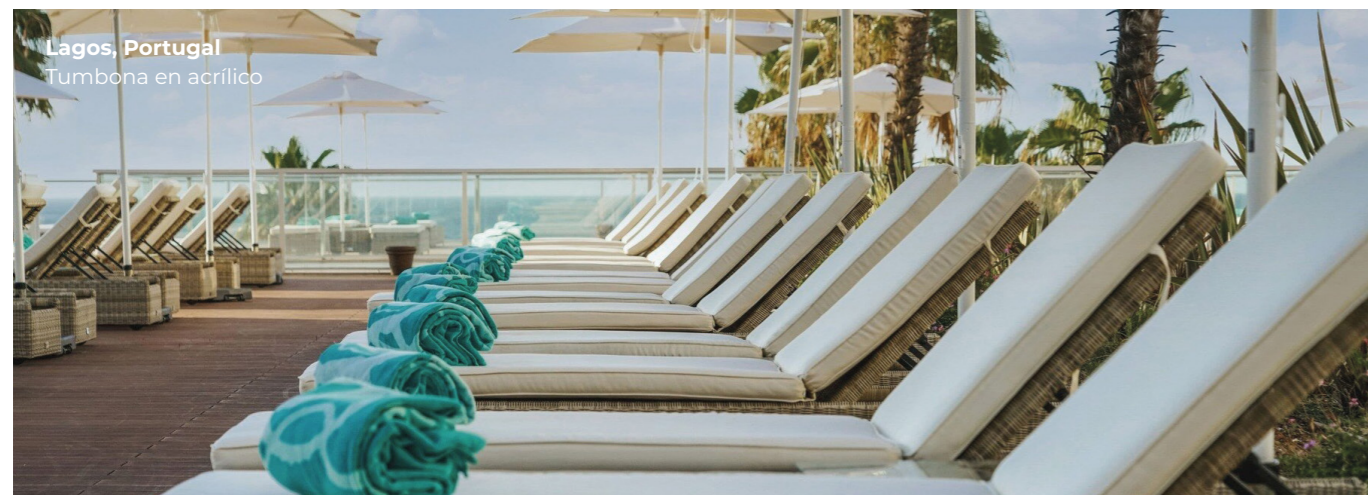

Lagos, Portugal
Tumbona en acrílico

COJINES TUMBONA

SUNBED CUSHIONS / COUSSIN DE TRANSAT

VINILOS NÁUTICOS



- Medidas especiales
Special measures
Mesures spéciales

COMPOSICIÓN / COMPOSITION / COMPOSITION

Vinilo y poliéster / Vinyl and polyester / Vinyle et polyester

RELLENO / FILLING / GARNITURE

Espuma de poliuretano alta densidad / High density polyurethane foam / Mousse de polyuréthane haute densité

CARACTERÍSTICAS Y BENEFICIOS / FEATURES AND BENEFITS / CARACTÉRISTIQUES ET AVANTAGES

Repelente al agua, resistente al exterior y fácil mantenimiento / Water repellent, outdoor resistant and easy to maintain / Hydrofuge, résistant à l'extérieur et facile à entretenir.

OPCIONES VINILO / VINYL OPTIONS / OPTIONS VINYLE

Nautic Class **Nautic Bio Plus** **Nautic Melange**

ACRÍLCOS



- Medidas especiales
Special measures
Mesures spéciales

COMPOSICIÓN / COMPOSITION / COMPOSITION

Acrílico 100% con opción tintado en masa

RELLENO / FILLING / GARNITURE

Espuma de poliuretano alta densidad / High density polyurethane foam / Mousse de polyuréthane haute densité

OPCIONES ACRÍLICO / ACRYLIC OPTIONS / OPTIONS ACRYLIQUES

Acrylic Basic

Acrylic Masa Soft

Garantía
5 años
solidez del color



Saint Cyprien, Francia
Tumbona en vinilo náutico melange

TEXTILENE / BATYLINE



- Adaptación a su mobiliario
Adaptation to your furniture
Adaptation à votre mobilier



Fibra compacta
Compact fiber
Fibre compacte



No absorbente
Non absorbent
Système drainant

COMPOSICIÓN / COMPOSITION / COMPOSITION

Hilos de poliéster recubierto de PVC / PVC coated polyester yarns / Fils de polyester enduits de PVC

RELLENO / FILLING / GARNITURE

Fibra compacta permeable y no absorbente / Permeable and non-absorbent compact fiber / Fibre compacte perméable et non absorbante

CARACTERÍSTICAS Y BENEFICIOS / FEATURES AND BENEFITS / CARACTÉRISTIQUES ET AVANTAGES

Repelente al agua, resistente al exterior y fácil mantenimiento / Water repellent, outdoor resistant and easy to maintain / Hydrofuge, résistant à l'extérieur et facile à entretenir.

COLORES TEXTILENE / COLORS / COULEURS

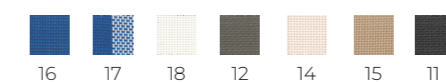

COLORES BATYLINE / COLORS / COULEURS

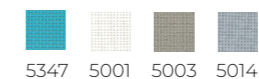

Garantía
5 años
solidez del color

*Consultar otros colores / Consult other colors / Autres couleurs sur demande



COJINES TERRAZA

TERRACE CUSHIONS / COUSSINS DE TERRASSE



Fabricación de cojines para terrazas, interior y exterior, con posibilidad de personalización mediante serigrafía o vinilo.

Manufacture of cushions for terraces, indoors and outdoors, with the possibility of customization by means of silk-screen printing or vinyl.

Fabrication de coussins pour les terrasses, à l'intérieur et à l'extérieur, avec possibilité de personnalisation par sérigraphie ou vinyle.



TEJIDOS DISPONIBLES / AVAIBLE FABRICS / TISSUS DISPONIBLES

Acrylic Basic Acrylic Masa Soft Nautic Class Nautic Bio Plus Nautic Melange

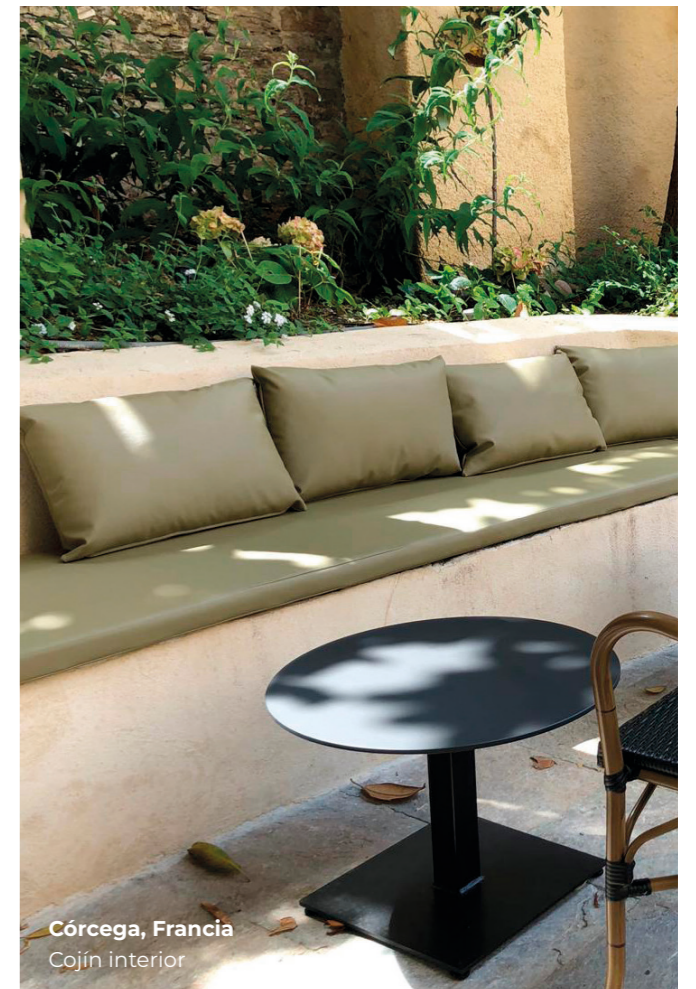

COJÍN INTERIOR/EXTERIOR

INDOOR AND OUTDOOR CUSHIONS / COUSSIN DE TRANSAT

Cojines fabricados en gran variedad de tejidos y medidas especiales.

Cushions manufactured in a wide variety of fabrics and special sizes.

Coussins fabriqués dans une grande variété de tissus et de dimensions spéciales.



TEJIDOS DISPONIBLES / AVAIBLE FABRICS / TISSUS DISPONIBLES

Acrylic Basic Acrylic Masa Soft Nautic Class Nautic Bio Plus Nautic Melange

05 COMPLEMENTOS



SEPARADORES, INFRARROJOS Y ILUMINACIÓN

Barcelona, España
SEPM100H | Separador jardinera



SEPARADORES SEPARATORS / SÉPARATEURS



REF. BS180
PLAYA
180x80 cm
4,70 kg



REF. SPTZ150MS
TERRAZA
105x150 cm
6,30 kg



REF. SPR150PVC
COVID
150x150 cm
7,24 kg

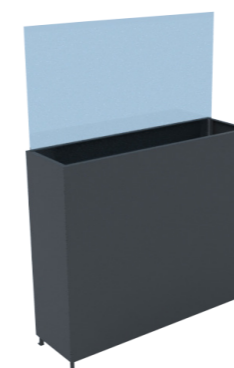

REF. SEPM100HCRE
JARDINERA CON CRISTAL
140x96,5x22 cm
38 kg



REF. SEPM100H
JARDINERA SIN CRISTAL
96,5x22x91 cm

Saint Jean de Fos, Francia
SPR150PVC | Separador Covid

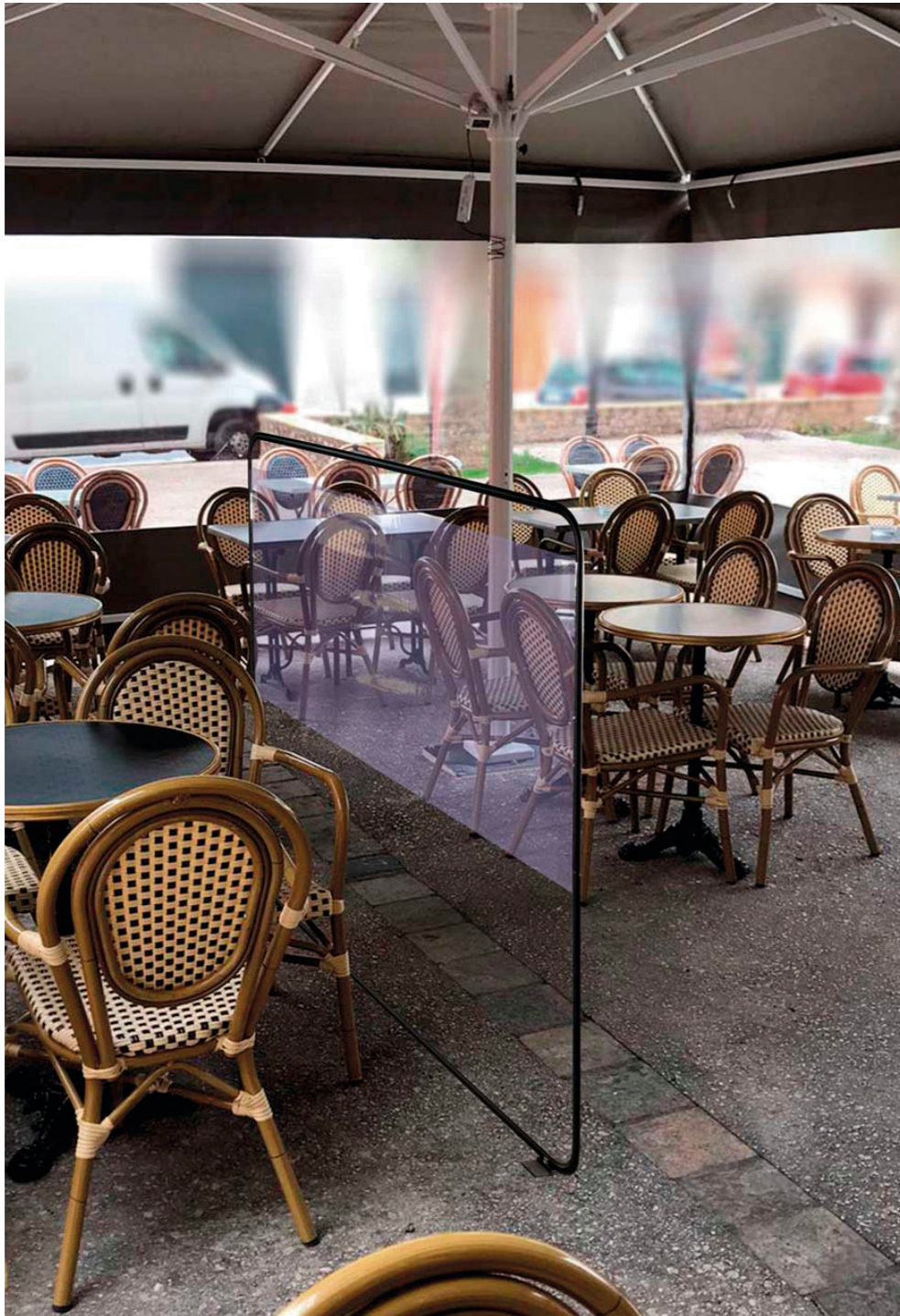

Barcelona, España
SPTZ150MS | Separador Terraza

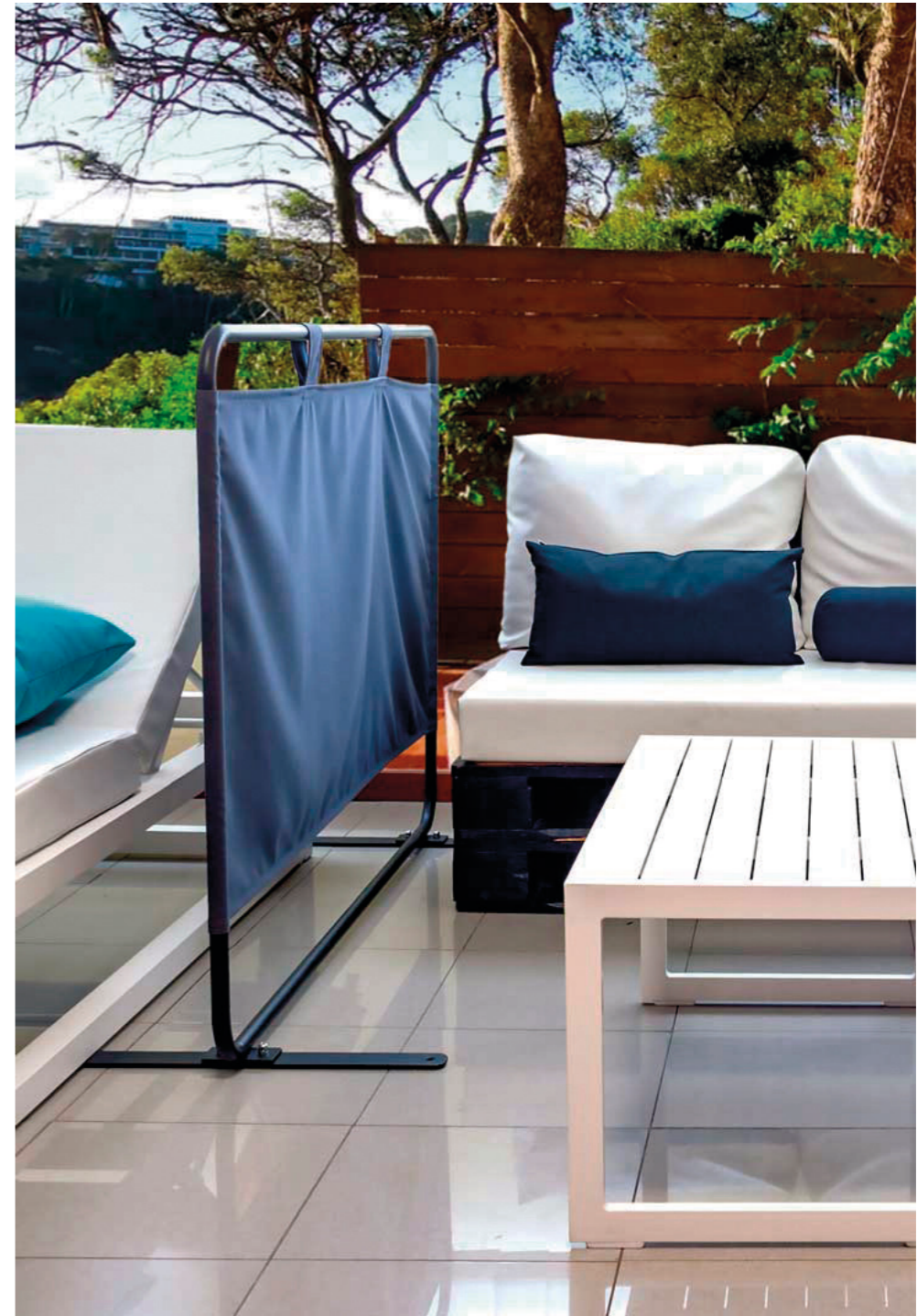



Elche, Alicante (España)
EST20CA | Lámpara carbono

CALEFACTORES INFRARROJOS CORTOS

SHORT INFRARED HEATERS / CHAUFFAGES INFRAROUGES COURTS

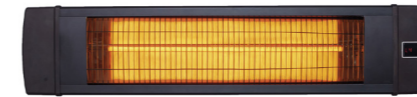

REF. EST20CA
LÁMPARA CARBONO

- 88x19x8 cm
- 3 kg
- 96x29x51 cm

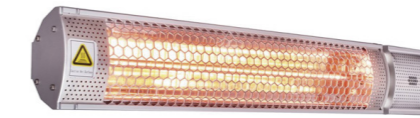

REF. EST20HA
LÁMPARA HÁLOGENA

- 68x11x7 cm
- 1,6 kg
- 75x54x34 cm

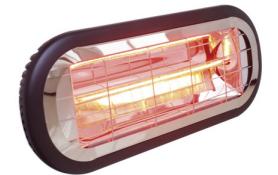

REF. EST20LG
LÁMPARA HÁLOGENA

- 46x19x12 cm
- 2,8 kg
- 46x33x54 cm

*Compatible soporte parasol



REF. EST-PIE
Ajustable de 1,2 a 2,1 m
9 kg



REF. EST-SOP
20,5x7,5x4 cm
1,17 kg



ref	color color couleur	protección protection protection	potencia power puissance	mando distancia remote control télécommande
EST20CA	Negro	IP55	4	Si
EST20HA	Plateado	IP65	2	Si
EST20LG	Negro	IP65	-	No

Luces de led RGB



ILUMINACIÓN LED

LED LIGHTING / ÉCLAIRAGE LED

Kit de iluminación con conexión a batería, con elementos resistentes a condiciones climatológicas adversas.

Lighting kit, with elements resistant to adverse weather conditions.

Kit d'éclairage batterie ou sur seteur.

Incluido / Including / Includant



ref	luz light lumière	conexión connection connexion	mando command télécommande	medida tira strip measure longueur baguette led
ILED50-BAT	Luz cálida o RGB	Batería	Si	50 cm x 4 ud

06 FUNDAS



FUNDAS PROTECTORAS

RIPSTOP

RIPSTOP / RIPSTOP

Fundas con tejido reciclable y confeccionadas con poliéster Ripstop. Fabricación con medidas estándar.

Covers with recyclable fabric and made with Ripstop polyester. Manufactured in standard sizes.

Housses en tissu recyclable et fabriquées en polyester Ripstop. Fabriqué dans des tailles standard.

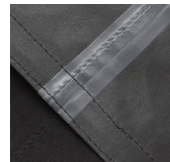

Costuras impermeables
Waterproof seams
Coutures imperméables



Ajuste óptimo con cuerda y freno, fácil de tensar
Optimal adjust with cord and stopper, easy to tighten
Ajustement optimal avec cordon et boyuchon, facile à serrer



Resistente al agua
Water resistant
Resistant à l'eau.



Reduce la condensación y previene el crecimiento de moho y hongo

Reduces condensation and prevent from mould and mildew

Réduit la condensation et évite les moisissures



Peso reducido | Fácil manipulación | Reducido almacenaje

Light weight | Easy handle | Reduced storage

Léger | Facile manipulation | Emballage compact

MULTITEX

MULTITEX / MULTITEX

Fundas con tejido reciclable y una garantía de 3 años. Fabricación estándar y a medida.

Covers with recyclable fabric and a 3-year warranty. Standard and custom manufacturing.

Housses avec tissu recyclable et garantie de 3 ans. Standard et sur mesure.



Tejido impermeable / Poliéster AT (280 Dtx) / Recubrimiento PVC

Waterproof fabric / Polyester AT (280 Dtx) / PVC coating

Tissu imperméable / Polyester AT (280 Dtx) / Revêtement de PVC



Incluido cordón para ajuste inferior mediante ollados

Cord included to tight

Cordon de réglage inférieur inclus



Chimenea de ventilación que permite la circulación de aire y disminuye la condensación.

Ventilation chimney that allows air circulation and reduces condensation

Cheminée de ventilation qui permet la circulation de l'air et réduit la condensation



Gran solidez del color frente a unas condiciones normales de exposición.

High color fastness under normal exposure conditions.

Grande solidité des couleurs, contre les conditions normales d'exposition au soleil



F/XR-S06 (100x100x70 cm)
F/XR-S07 (170x100x70 cm)
F/XR-S08 (246x95x69 cm)



F/XR-MR11 (Ø200x85 cm)

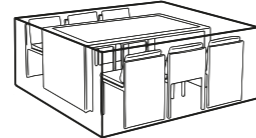

F/XR-MS04 (305x190x85 cm)
F/XR-MS05 (200x190x85 cm)

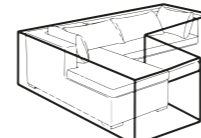

F/XR-SL09 (295x295x98x68 cm)

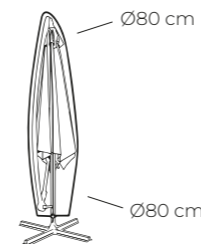

103.1587 (h270cm)

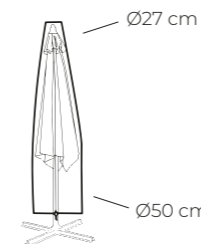

103.1588 (h235 cm)

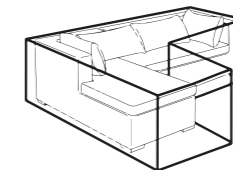

103.1952 (220+220x85x70 cm)
103.1948 (300+300x100x70 cm)

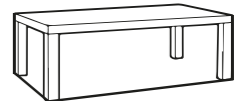

103.1582 (120x70x45 cm)
103.1583 (140x95x35 cm)

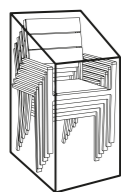

F/XR-SA03 (75x78x65/110 cm)

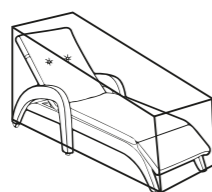

F/XR-TA10 (210x75x40 cm)

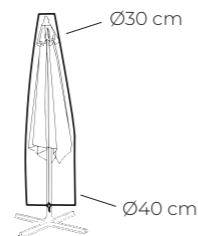

F/XR-PC01 (h230 cm)

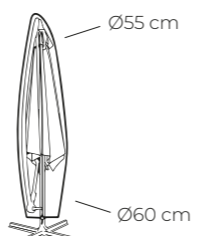

F/XR-PL02 (h250 cm)

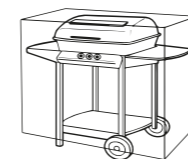

103.1581 (145x60x100/85 cm)
103.1959 (Ø66x100 cm)



103.1675 (Ø160x85 cm)
103.1585 (200x130x85 cm)
103.1586 (230x130x85 cm)
103.1584 (290x190x85 cm)

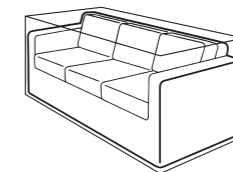

103.1674 (148x100x85/60 cm)
103.1591 (205x100x85/60 cm)
103.1592 (261x100x70 cm)
103.1954 (145x80x65 cm) 2 plazas Mini

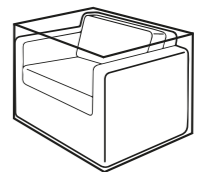

103.1589 (90x85x85/60 cm)
103.1590 (115x95x70 cm)
103.1953 (80x80x65 cm) Mini
103.1949 (75x78x110/65 cm) Apilable

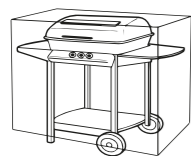

F/XR-BC01 (145x61x109 cm)



F/XR-BR01 (Ø67x70 cm)

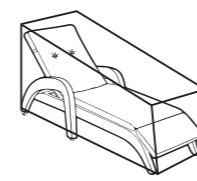

103.1594 (78x210x50 cm)
103.1593 (145x215x45 cm)
103.1955 (65x202x42 cm)

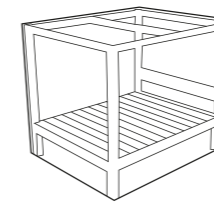

103.1956 (205x175x200 cm)
103.1957 (205x155x200 cm)
103.1958 (205x205x200 cm)



07

CARTA COLORES

AMPLIA GAMA DE COLORES

Acrylic Basic



Para exterior e interior, con tratamiento repelente a los líquidos y la suciedad.

For exterior and interior, with liquid and dirt repellent treatment.

Pour extérieur et intérieur, avec traitement anti-liquides et anti-salissures.

COLORES ESTÁNDAR / STANDARD COLORS / COULEURS STANDARD

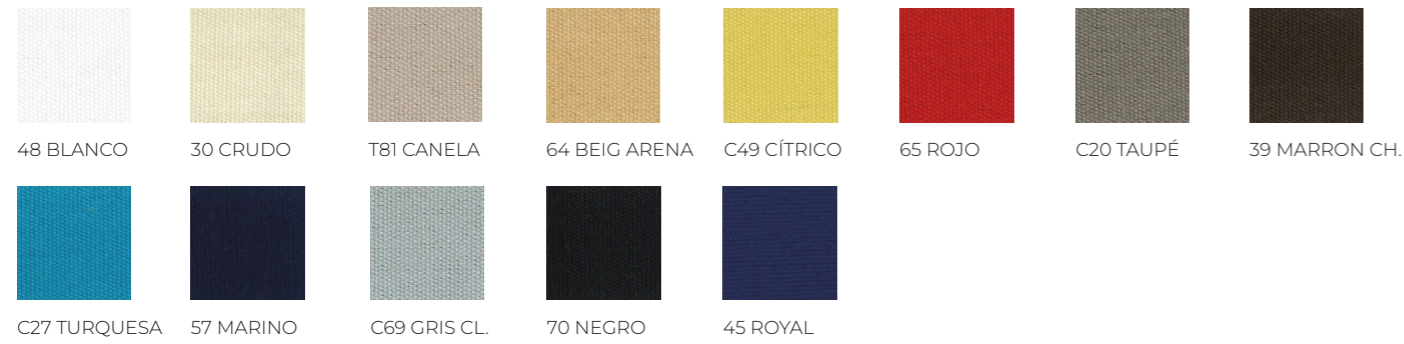

OTROS COLORES (CONSULTAR DISPONIBILIDAD) / OTHER COLORS (CHECK AVAILABILITY) / AUTRES COULEURS (VÉRIFIER LA DISPONIBILITÉ)



Olefin



Para exterior e interior, con tratamiento repelente a los líquidos y la suciedad. Alta solidez a la luz y al agua clorada.

For exterior and interior, with liquid and dirt repellent treatment. High resistance to light and chlorinated water.

Pour extérieur et intérieur, avec traitement anti-liquides et anti-salissures. Haute solidité à la lumière et à l'eau chlorée.

190 gr



250 gr



Acrylic Masa Soft



Para exterior e interior, con tratamiento repelente a los líquidos y la suciedad. Alta solidez a la luz.

For exterior and interior, with liquid and dirt repellent treatment. High resistance to light.

Pour extérieur et intérieur, avec traitement anti-liquides et anti-salissures. Déperlant.

COLORES ESTÁNDAR / STANDARD COLORS / COULEURS STANDARD



OTROS COLORES (CONSULTAR DISPONIBILIDAD) / OTHER COLORS (CHECK AVAILABILITY) / AUTRES COULEURS (VÉRIFIER LA DISPONIBILITÉ)



Polyester

Tejido beig estándar Standard beige fabric Polyester beige standard

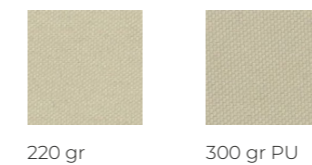

Acrylic Masa Forte



Para exterior e interior, con tratamiento repelente a los líquidos y la suciedad. Alta solidez a la luz.

For exterior and interior, with liquid and dirt repellent treatment. High resistance to light.

Pour extérieur et intérieur, avec traitement anti-liquides et anti-salissures. Déperlant.

COLORES ESTÁNDAR / STANDARD COLORS / COULEURS STANDARD



2042 BLANCO 2143 MARFIL 8488 ANTRACITA 2170 NEGRO 2101 GRANATE

OTROS COLORES (CONSULTAR DISPONIBILIDAD) / OTHER COLORS (CHECK AVAILABILITY) / AUTRES COULEURS (VÉRIFIER LA DISPONIBILITÉ)



2296 AVENA 2146 MARRÓN 2316 CAFÉ 2211 ROJO 2209 BRASSERIE 2831 MINERAL 2018 AZUL 2145 MARINO
2013 AMARILLO 2979 PERLA 2245 VERDE B 2242 VERDE 8645 TERRACOTA 2142 MANDARINA 2129 TURKIS

Textilene



Para exterior, hilo de poliéster recubierto de PVC.

For outdoor use, PVC-coated polyester thread.

Pour utilisation en extérieur, fil de polyester enduit de PVC.



11 ANTRACITA 15 BEIGE 12 TAUPÉ 18 BLANCO 14 CRUDO 16 AZUL 17 AZUL-BCO

Nautic Class



00 BLANCO 04 CRUDO 05 BEIGE 18 PIEDRA 92 TRUFA 72 PIZZARRA 75 PLOMO 90 NEGRO
60 CARIBE 61 TURQUESA 68 AZUL 41 PISTACHO 09 OCRE 17 TEJA 29 ROJO

Nautic Bio Plus



300 BLANCO 304 CREMA 305 CAMEL 315 TIERRA 390 NEGRO 387 PLOMO 340 SELVA 369 NAVY
317 TROPIC 341 LIMA

Nautic Melange



200 BLANCO 202 IVORY 229 ROJO 241 PITACHO 275 GRIS 269 NAVY 207 PIEDRA

ESPECIFICACIONES
 AVAILABLE FABRICS
 TISSUS DISPONIBLES

Características generales	Acrylic Basic	Olefin	Polyester	Acrylic Masa Soft	Acrylic Masa Forte	Textilene	Nautic Class	Nautic Bio Plus	Nautic Melange
Acabado: Finish: Finition:	Hidrófugo Water-repellent Hydrofugue	Hidrófugo Water-repellent Hydrofugue	Hidrófugo Water-repellent Hydrofugue	Hidrófugo Water-repellent Hydrofugue	Hidrófugo Water-repellent Hydrofugue	Permeable Permeable Perméable	Impermeable	Impermeable	Impermeable
Composición: Composition: Composition:	100% Dralón Dralon 100% Dralon 100%	100% Olefin Olefin 100% Olefin 100%	100% poliéster Polyester 100% Polyester 100%	100% Fibra acrílica tintada a la masa.	100% Fibra acrílica tintada a la masa.	Hilo de poliéster recu- biero de PVC	90% vinilo / 10% poliéster	87% vinilo / 13% poliéster	90% vinilo / 10% poliéster
Peso: Weight: Poids:	195-220 gr/m ²	190-250 gr/m ²	220 / 300 gr/m ²	260 gr/m ²	300 gr/m ²	480 gr/m ²	700 gr/m ²	630 gr/m ²	830 gr/m ²
Resistencia UV: U.V. Resistance: U. V. Résistance:	CERTIFIED UV PROTECT 40 - 30	UV STANDARD 801 Blocks more than 97% of uv rays	—	1000 horas	—	—	1.300 horas	1.000 horas	1.000 horas
Solidez a luz: Light fastness: Solidité à la lumière:	6-7/8 (UNE EN ISO 105-B02:2001 Método 5)	5 años de garan- tía (en condicio- nes normales de exposición).	—	5 años de garantía (en condiciones normales de exposición).	10 años de garantía (en condiciones normales de exposición).	6-7/8	7 (ISO 105-B02)	7 (ISO 105-B02)	6 (ISO 105-B02)
Resistencia a la abrasión: Abrasion resistance: Résistance à l'abrasion	20.000 cycles	20.000 cycles	—	28.000 cycles	NO TESTADO NOT TESTED PAS TESTÉ	NO TESTADO NOT TESTED PAS TESTÉ	EN ISO 12947-2:1998 >100.000 CICLOS	EN ISO 12947-2:1998 >100.000 CICLOS	EN ISO 12947-2:1999 >100.000 CICLOS
Resistencia a la tracción (urdimbre / trama): Breaking resistance (warp / weft): Résistance à la rupture (chaîne / trame):	NO TESTADO NOT TESTED PAS TESTÉ	1647 N / 750 N (UNE EN ISO 13934-1)	NO TESTADO NOT TESTED PAS TESTÉ	1600 N / 800 N 5 cm. ISO 13934-1	1400 N / 950 N 5 cm. UNE EN 1394.1	NO TESTADO NOT TESTED PAS TESTÉ	ISO 13934-1 N/ 5 cm ≥ 170	ISO 13934-1 N/ 5 cm ≥ 150	ISO 13934-1 N/ 5 cm ≥ 150
Alargamiento a la rotura (urdimbre / trama): Breaking elongation (warp / weft): Allongement à la rupture (chaîne / trame):	986 N / 525 N (UNE EN ISO 13936-1:1999)	—	NO TESTADO NOT TESTED PAS TESTÉ	28% / 18% ISO 13934-1	NO TESTADO NOT TESTED PAS TESTÉ	NO TESTADO NOT TESTED PAS TESTÉ	ISO 13934-1 ≥ 25% ≥ 50%	ISO 13934-1 ≥ 25% ≥ 50%	ISO 13934-1 ≥ 25% ≥ 50%
Resistencia al desgarro (urdimbre / trama): Tear resistance (warp / weft): Résistance au déchirement (chaîne / trame):	NO TESTADO NOT TESTED PAS TESTÉ	73,9 N / 43,2 N (UNE EN ISO 13937-3)	NO TESTADO NOT TESTED PAS TESTÉ	60 N / 50 N ISO 13937-2	NO TESTADO NOT TESTED PAS TESTÉ	NO TESTADO NOT TESTED PAS TESTÉ	ISO 13937-2 ≥ 35 N ≥ 50 N	ISO 13937-2 ≥ 25 N ≥ 40 N	ISO 13937-2 ≥ 35 N ≥ 50 N
Tratamiento ignifugo: Fire retardant treatment: Traitement ignifuge:	NO	NO	NO	NO	NO	NO	UNE 1021 Parts 1-2 IMO A652 BS5852 Cigarette & Match	UNE 1021 Parts 1-2 IMO A652 BS5852 Cigarette & Match	UNE 1021 Parts 1-2 IMO A652 BS5852 Cigarette & Match
Tratamiento antibacteriano y antihongos: Antibacterial treatment and mildew resistance: Traitement antibactérien et résistance à la moisissure:	SI	NO	NO	SI	SI	NO	SI	SI	SI

La migración de pigmentos, tinturas y colorantes como los utilizados en el denim de algunos tejanos u otras prendas, es un efecto irreversible en esta tipología de productos, por lo que EXCLUSIVAS CONFORT VALLÉS, S.L. (CONVA) no puede asumir responsabilidad alguna en las manchas ocasionadas.

The migration of pigments, dyes and colorants like the ones used in some denim jeans or other clothes is an irreversible effect on this type of products, therefore EXCLUSIVAS CONFORT VALLÉS, S.L. (CONVA) cannot assume any responsibility for caused stains.

La migration des pigments, des colorants et des colorants comme ceux utilisés dans certains jeans en denim est un effet irréversible sur ce type de produits, donc EXCLUSIVAS CONFORT VALLÉS, S.L. (Conva) ne peut assumer aucune responsabilité pour les taches causées.